



blu

BATHWORKS®

furniture

pricelist

May 2026

where water meets modern™

45° collection

features + benefits	10
color + finish guide	12
series 700	18
series 900	22
series 1200	26
series 1400	30
series 1800	34
wall cabinet	38

45° FENIX™ collection

features + benefits	48
color + finish guide	50
series 700	56
series 900	58
series 1200	60
series 1400	62
series 1800	66
wall cabinet	70

51 collection

features + benefits	76
color + finish guide	78
series 600	82
series 700	85
series 900	89
series 1200	92
series 1400	95
series 1800	99

warranty + terms	104
inventory	106
contact	107

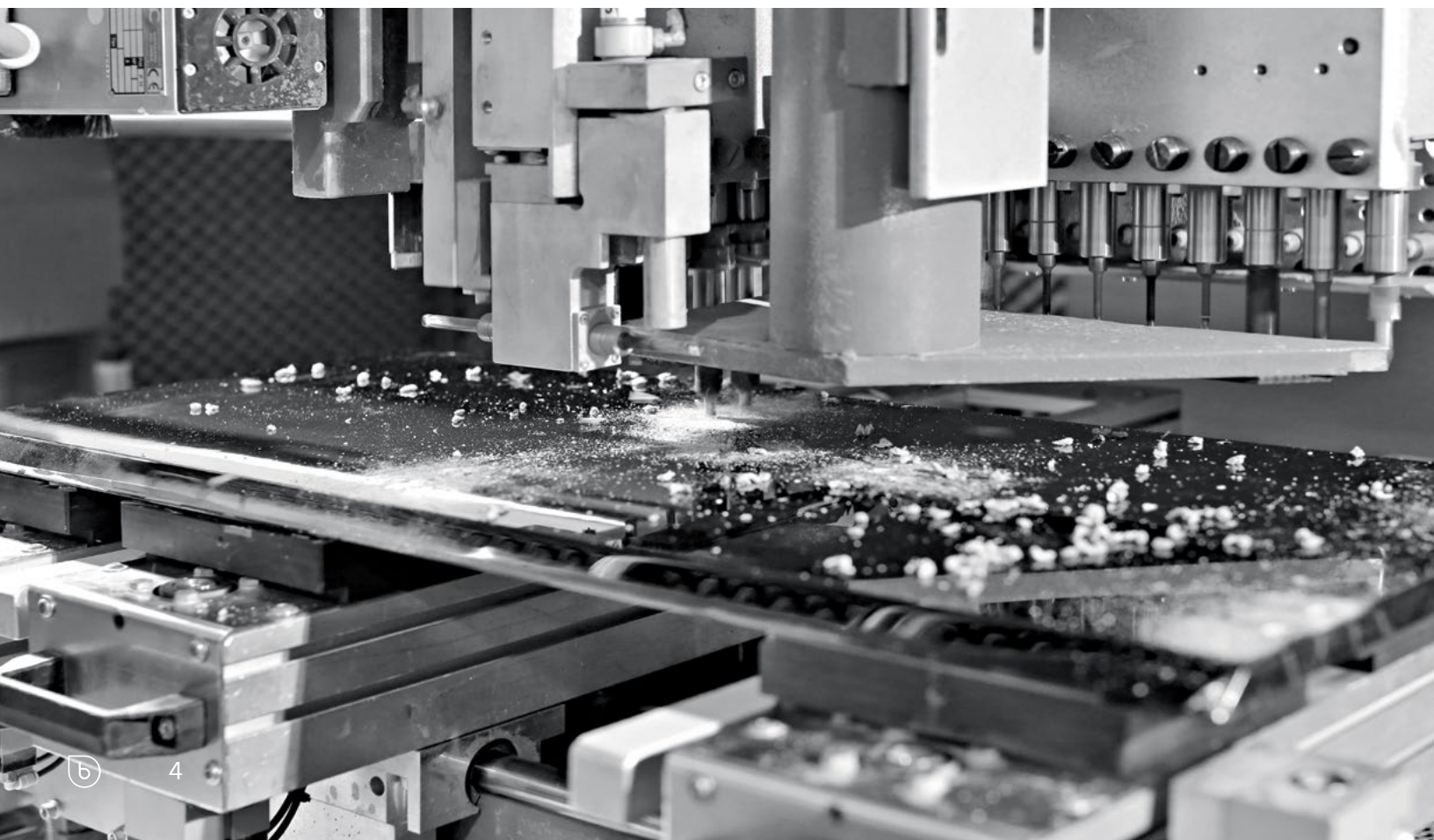



Beautiful Italian-crafted furniture collections

by Blu Bathworks®

modern architectural sustainable design

With an inherent passion for water conservation, Blu Bathworks® is committed to developing sustainable products for an ecological future.

This passion motivated us to create our signature eco-friendly blu·stone™ material, which – in addition to its low-energy production process and recyclable nature – provides superior water temperature retention, requiring less water consumption for an optimum bathing experience.

“ Our newest product selection reflects our continued vision and pursuit of design and product innovation. ”

Blu Bathworks’ Italian-crafted 45º, 45° FENIX™ and 51 furniture collections are another example of our sustainable design & production philosophy - created with Idroleb ecological panels with the lowest formaldehyde emissions in the world & designed to coordinate with eco-friendly blu·stone™ vanity tops.

Sustainability is an expression of our corporate culture, expressed in our attitude, product offering, as well as our production processes. We continue to evolve our working relationships to constantly review and optimize our production practices from an ecology viewpoint.

codes + compliance

Blu is proud to feature a selection of sustainable and certified products, that meet or exceed the highest standards, including:



Certificate that guarantees the use of panels with formaldehyde emissions lower than the minimum required by the European standard UNI EN13896



Certificate attesting to the legality of forest and industrial transformation operations, and to the traceability of wood from rainforests.



Certificate of treatment of panels with water repellent resins



Forest Stewardship Council certified products



LEED certified products



UPC/cUPC



UL Listed



CSA certified products

45°

furniture collection

vanities
mirror
cabinet

furniture



45° collection series 1400 mirror F45M1-1400-02

45° collection series 1400 FULL vanity frame F45V1-1400.1-03M + drawer fronts FV1D-1400.1-03

blu-stone™ series 1400 vanity top basin SA1400.01-01M

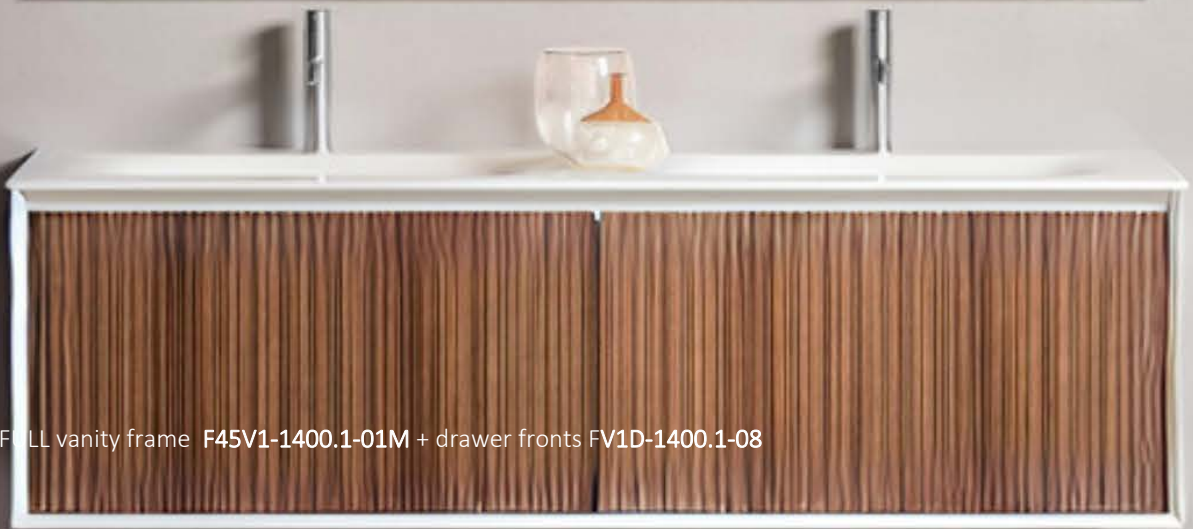

45° collection series 1400 FULL vanity frame F45V1-1400.1-01M + drawer fronts FV1D-1400.1-08



45° collection series 1200 FULL vanity frame F45V1-1200.1-01M + drawer fronts FV1D-1200.1-09

features + benefits

Blu Bathworks 45 degree furniture collection is Italian-crafted using quality, sustainable materials with the lowest formaldehyde emissions in the world. The collection is designed as a modular range of wall-mount vanities from 27½" to 71" wide, with coordinating blu-stone™ vanity tops and mirrors with LED lighting.



Unique 45° Design Feature

The entire 45° furniture collection is characterized by a unique 45 degree design feature, which is achieved in 45° vanity frames by die cutting the wood material and delicately folding the pieces to create 45° joins on the two lower angles. This design feature is evident on all four angles of the mirror frames and vanity drawer tops – and serves to further elevate the quality craftsmanship inherent in this collection.



Vanity Design Options

45° collection offers two vanity design options: FULL features a slim inner drawer within a drawer design, which provides quick & easy access to smaller items, while facilitating a clean, minimalist look externally. UP vanity design provides a single drawer with an open bottom shelf to store and display towels and other toiletries.

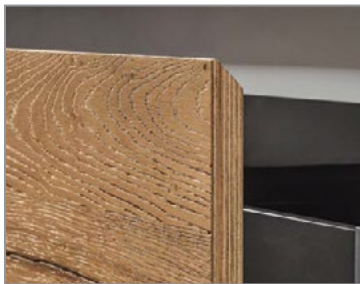

Hettich Soft-Close System

Promoting a minimalist, handle-free aesthetic, all 45° vanities feature a recessed finger pull channel to easily open the drawer, while Hettich technology is incorporated to provide a smooth, soft-close operation every time.



Plumbing Clearance Drawer Design

The slim drawer within a drawer design of 45° vanities provide quick & easy access to smaller items, while facilitating a clean, minimalist look externally. Vanity drawers are designed to maximize storage space while separating stored items from plumbing drain pipes.



Coordinating blu-stone™ Vanity Tops

Vanity tops are available in Blu Bathworks signature eco-friendly blu-stone™ material – crafted primarily from quartzite – in a range of widths from 27¾” to 71” to coordinate with each 45° vanity. All blu-stone™ vanity tops are available in ½” thickness with choice of matte or gloss finish; series 1200 & 1400 are also available in 1-4” thickness.



Vanity Drawer Organization is Standard

To facilitate bathroom organization, each 45° vanity is equipped with a range of storage compartments, bins + cosmetic holders. Drawer organization kits are also available separately for additional custom storage requirements.



Mirror with LED Lighting

An LED perimeter light, subtly positioned behind the frosted edging, is standard with each 45° collection mirror - omitting a soft glow (colour temperature: 4200K). Lighting is operated by a discreet ¼” touch sensor switch, located on the mirror face. Mirrors are available in a natural oak wood or matte white lacquer finish to coordinate with 45° vanities.

Quick & Easy Installation

Great care has been taken in the design of 45° vanities and mirrors to ensure convenient installation, including an integral channel on the backside of each mirror to allow the installer to adjust brackets to hit studs accordingly. Similarly, all 45° vanities are equipped with one continuous bracket along the backside to allow easy retro-fitting / hitting studs where backing or additional support is not available.

finish + color guide

45° FULL VANITY

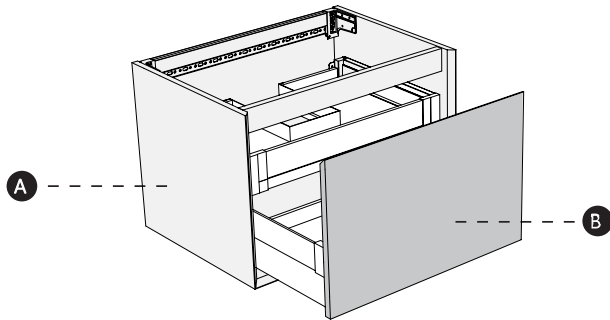

DESIGN OPTION: V1

45° UP VANITY

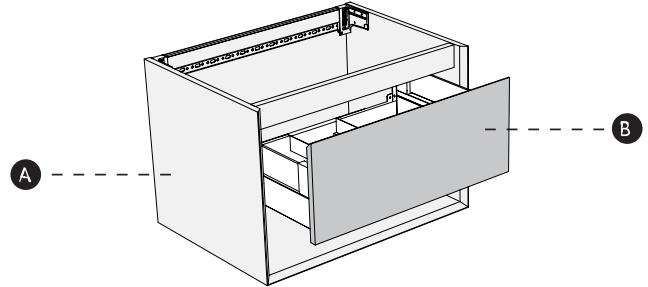

DESIGN OPTION: V2

Materials:

A vanity frame

Wood - Natural Oak
Constructed of real massif wood and wood veneer finish

Lacquer - Matte
Engineered wood (MDF) panel IDROLEB

B vanity drawer front

Wood - Natural Oak
Constructed of real massif wood and wood veneer finish

Wood - Vintage Oak
Wood veneer on a multi layer birch wood panel

Wood - Distressed Oak
Solid wood multi layer oak

Wood - Olmo
Wood veneer with vertical slats and light brushing to enhance the grain, mounted on a solid multi-layer birch wood panel.

Wood - Walnut & Rovere
Natural oak and walnut veneers with design engravings on black MDF.

Lacquer
Engineered wood (MDF) panel IDROLEB

Note: Wood is a natural product, therefore any variations in color, vein or finish are considered part of the wood's value and craftsmanship. Wood is a material that has its uniqueness and originality. For this characteristic, differences in grain and color tones can be found, which fall within the tolerances provided by the standards and which make each front unique.

How to order 45° vanities:

A Vanity frame SKU + furniture finish/color code
+ eg. UP series 900 vanity frame in White Matte (01M) lacquer finish = F45V2-0900.1-01M

B Drawer front SKU + furniture finish/color code
eg. UP series 900 drawer front in Distressed Oak (04) wood finish = FV2D-0900.1-04

Wood + Lacquer

Please refer to furniture sample chips for true finish and color.

45° vanity frame

stocked

white matte



01M

special order*
(Max 50% discount)

natural oak



02

45° vanity drawer front

stocked

natural oak



02

special order*
(Max 50% discount)

vintage oak



03

distressed oak



04

olmo smoke



05

walnut



08

rovere

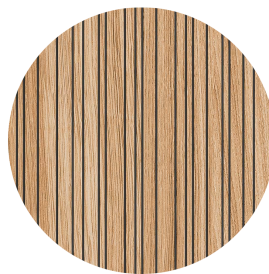

09

*Special Order finishes require a 16-20 weeks lead time upon 50% deposit confirmation

LACQUER

Please refer to furniture sample chips for true finish and color.

45° vanity drawer front

special order*

(Max 50% discount)

white



matte - 01M
gloss - 01G

black

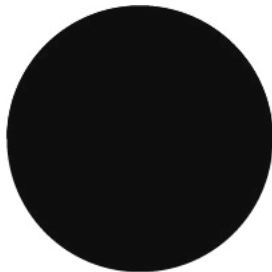

matte - 04M
gloss - 04G

efeso



matte - 62M
gloss - 62G

bromo

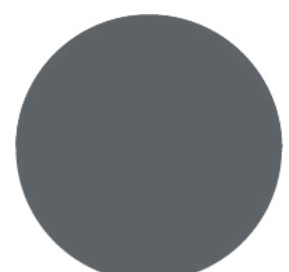

matte - 68M
gloss - 68G

ottawa

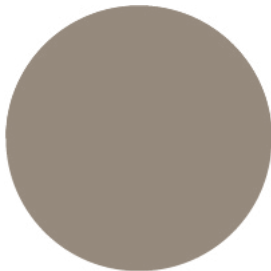

matte - 88M
gloss - 88G

londra

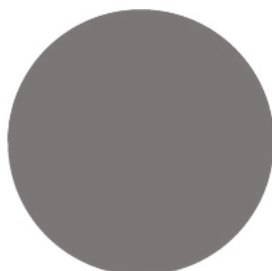

matte - 90M
gloss - 90G

jaipur

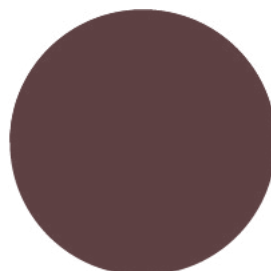

matte - 94M
gloss - 94G

orinoco

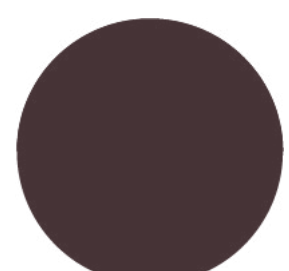

matte - 96M
gloss - 96G



45° collection series 1800 mirror F45M1-1800-01M

45° collection series 1800 UP vanity frame F45V2-1800.1-01M + drawer fronts FV2D-1800.1-03 blu-stone™

series 1800 vanity top basin SA1800.01-01M

source series deck faucet 1201-AS



Mirror Frame Finishes



Natural Oak wood · 02



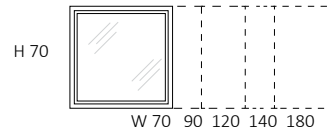

White Matte lacquer · 01M

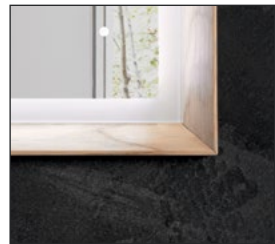
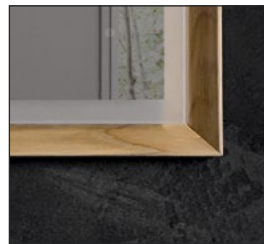

LED Perimeter Light



110V STRIP LED 9.6 W/MT 12V 4200°K

   IP 44

Touch Sensor Switch

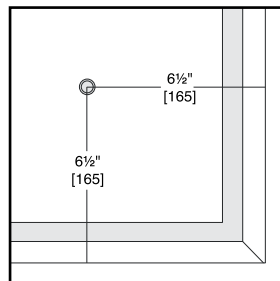

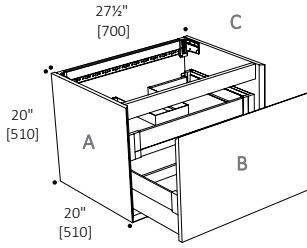

* special order finishes require 16 - 20 weeks lead time upon 50% deposit confirmation *

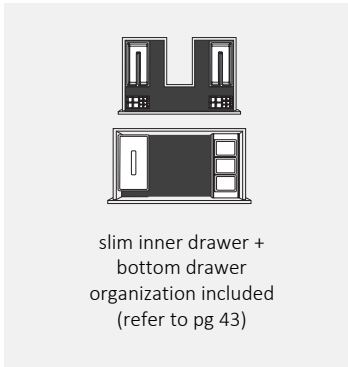

(A) F45V1-0700.1 + (B) FV1D-0700.1

- 27½" W × 20" H × 20" D / 700mm W x 510mm H x 510mm D
- Wall-mount vanity with deep drawer + slim drawer insert
- The two lower angles feature a unique 45 degree joint
- Drawer organization included: 2 storage compartments, 2 cosmetic holders, 1 storage bin set + 1 tissue box.
- Slim inner drawer designed for plumbing clearance
- Recessed integral finger pull channel with Hettich soft-close system
- Designed to coordinate with series 700 blu-stone™ vanity top basin or countertop
- Vanity frame available in a choice of Natural Oak (02) wood finish or White Matte (01M) lacquer; drawer fronts available in a range of wood and lacquer finishes + colors

(A) vanity frame

- F45V1-0700.1-01M *(in stock)*
- F45V1-0700.1-02* *(special order)*

+

(B) wood drawer front

- FV1D-0700.1-02 *(in stock)*
- FV1D-0700.1-03* *(special order)*
- FV1D-0700.1-04* *(special order)*
- FV1D-0700.1-05* *(special order)*
- FV1D-0700.1-08* *(special order)*
- FV1D-0700.1-09* *(special order)*

or

(B) lacquer drawer front

- FV1D-0700.1-01M/04M/62M/68M/88M/90M/94M/96M* *(special order)*
- FV1D-0700.1-01G/04G/62G/68G/88G/90G/94G/96G* *(special order)*

+

(C) blu-stone™ vanity top + countertop

View options, refer to page 20

How to order 45° vanities:

Vanity frame SKU + finish/color code
eg. FULL series 700 vanity frame in White Matte (01M) lacquer finish = **F45V1-0700.1-01M**

How to order 45° vanities:

Drawer front SKU + finish/color code
eg. FULL series 700 drawer front in Black Gloss(04G) lacquer finish = **FV1D-0700.1-04G**

Stocked



natural oak 02

Special Order Finishes



vintage oak 03



distressed oak 04



olmo smoke 05



walnut 08



Rovere 09



white matte 01M gloss 01G



black matte 04M gloss 04G



efeso matte 62M gloss 62G



bromo matte 68M gloss 68G



ottawa matte 88M gloss 88G



londra matte 90M gloss 90G



jaipur matte 94M gloss 94G



orinoco matte 96M gloss 96G

(A) F45V2-0700.1 + (B) FV2D-0700.1

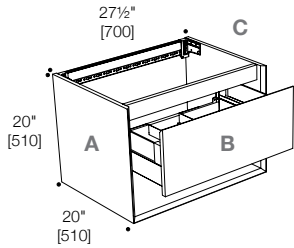

- 27½" W × 20" H × 20" D / 700mm W x 510mm H x 510mm D
- Wall-mount vanity with single drawer + open bottom shelf
- The two lower angles feature a unique 45 degree join
- Drawer organization included: 1 storage compartment, 2 cosmetic holders + 1 storage bin set.
- Drawer designed for plumbing clearance
- Recessed integral finger pull channel with Hettich soft-close system
- Designed to coordinate with series 700 blu-stone™ vanity top basin or countertop
- Vanity frame available in a choice of Natural Oak (O2) wood finish or White Matte (O1M) lacquer; drawer fronts available in a range of wood and lacquer finishes + colors.

(A) vanity frame

F45V2-0700.1-01M *(in stock)*
 F45V2-0700.1-02* *(special order)*

+

(B) wood drawer front

FV2D-0700.1-02 *(in stock)*
 FV2D-0700.1-03* *(special order)*
 FV2D-0700.1-04* *(special order)*
 FV2D-0700.1-05* *(special order)*
 FV2D-0700.1-08* *(special order)*

OR

(B) lacquer drawer front

FV1D-0700.1-01M/04M/62M/68M/88M/90M/94M/96M* *(special order)*
 FV1D-0700.1-01G/04G/62G/68G/88G/90G/94G/96G* *(special order)*

+

(C) blu-stone™ vanity top + countertop

View options, refer to page 20

* special order finishes require 16 - 20 weeks lead time upon 50% deposit confirmation *



drawer organization included (refer to pg 43)

F45M1-0700 * Limited Stock *

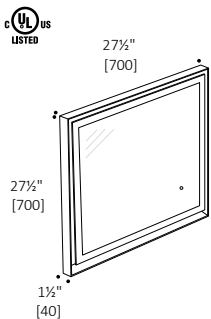

- 27½" W × 27½" H × 1½" D / 700mm W x 700mm H x 40mm D
- M1 framed mirror with soft LED perimeter lighting and touch sensor switch
- 110V strip LED 9.6 W/MT RV 4200K
- Unique 45 degree join on all four angles
- Frosted edging around mirror perimeter
- Mirror frame available in a choice of White Matte (O1M) or Black Matte (O4M) lacquer or Natural Oak (O2) wood finish.
- LED light strip 3000K is available can be replaced onsite PT-F45M1-LED-STRIP-3
- Limited Stock

wood frame

F45M1-0700-02

lacquer frame

F45M1-0700-04M

How to order 45° mirrors:

Mirror SKU + finish/color code

eg. series 700 mirror in White Matte (O1M) lacquer finish = **F45M1-0700-01M**

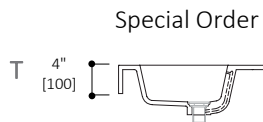
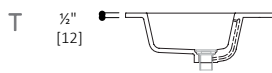
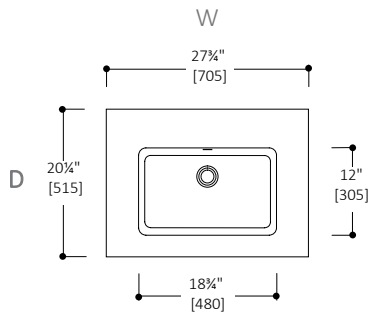

Top 27

SA0700.01-01M

(matte white)

(in stock)

SA0700.01-01G*

(gloss white)

(special order)

- 27³/₄" W x 20³/₄" D x 1/2" T / 705mm W x 515mm D x 12mm T
- blu-stone™ vanity top with integrated basin and integral slot overflow
- Basin: 18³/₄" W x 5" H x 12" D / 480mm W x 128mm H x 305mm D
- Knockouts may be drilled on-site for deck-mount faucet
- Includes matching blu-stone™ waste cover
- Available in a range of blu-stone™ colors + finishes
- Designed to coordinate with series 700 45° or 51 collection vanities (refer to pg 102 B)
- Recommend QTW-0121 push button waste; designed for use with blu-stone™ waste cover or SC015 universal push button waste

Special Order Finishes

for 1/2" or 1" - 4" apron thickness:



*Special Order finishes require a 20+ week lead time

*Special Order finishes are Made to Order and non-returnable

*Any Sherwin Williams color is available without additional up-charge and based on 1 round of sample

* advise height when ordering

1/2" thickness

SAC0700.01-01M*

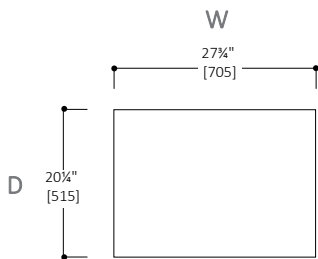

- 27³/₄" W x 20³/₄" D x 1/2" T / 705mm W x 515mm D x 12mm T
- blu-stone™ vanity countertop
- May be drilled on-site for deck-mount faucet installation
- Only available in White Matte finish
- Designed to coordinate with series 700 45° or 51 collection vanities

*Special Order finishes require a 20+ week lead time

1/2" thickness

SABS1000.01-01M*

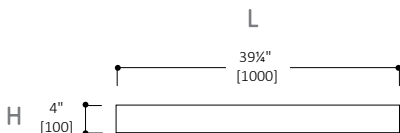

- 39¹/₄" W x 4" H x 1/2" D / 1000mm W x 100mm H x 12mm D
- Seamless, blu-stone™ vanity backsplash
- Can be cut to fit on-site
- Only available in White Matte finish
- Coordinate with 45° or 51 collection vanities including: series 600 / 700 / 900

*Special Order finishes require a 20+ week lead time upon



45° collection series 900 FULL vanity frame F45V1-0900.1-02 + drawer front FV1D-0900.1-03 blu·stone™

series 900 vanity top basin SA0900.01-01M

source series deck faucet 1201-AS

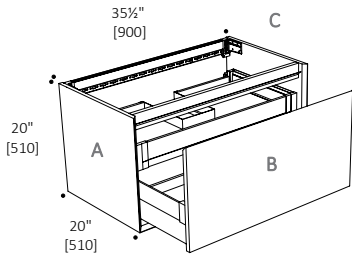

(A) F45V1-0900.1 + (B) FV1D-0900.1

- 35½" W × 20" H × 20" D / 900mm W x 510mm H x 510mm D
- Wall-mount vanity with deep drawer + slim drawer insert
- The two lower angles feature a unique 45 degree join
- Drawer organization included: 2 storage compartments, 4 cosmetic holders, 1 storage bin set + 1 tissue box.
- Slim inner drawer designed for plumbing clearance
- Recessed integral finger pull channel with Hettich soft-close system
- Designed to coordinate with series 900 blu-stone™ vanity top basin or countertop
- Vanity frame available in a choice of Natural Oak (02) wood finish or White Matte (01M) lacquer; drawer fronts available in a range of wood and lacquer finishes + colors.

* special order finishes require 16 - 20 weeks lead time upon 50% deposit confirmation *

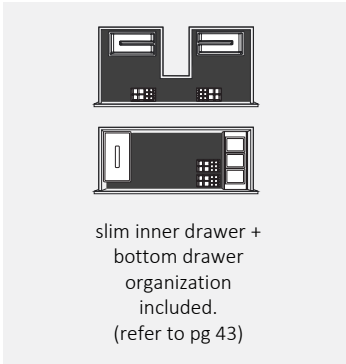

(A) vanity frame
F45V1-0900.1-01M *(in stock)*
F45V1-0900.1-02* *(special order)*

+

(B) wood drawer front
FV1D-0900.1-02 *(in stock)*
**FV1D-0900.1-03* *(special order)*
**FV1D-0900.1-04* *(special order)*
**FV1D-0900.1-05* *(special order)*
**FV1D-0900.1-08* *(special order)*
FV1D-0900.1-09* *(special order)*********

or

(B) lacquer drawer front
**FV1D-0900.1-01M / 04M / 62M / 68M / 88M / 90M / 94M / 96M* *(special order)*
FV1D-0900.1 - 01G / 04G / 62G / 68G / 88G / 90G / 94G / 96G* *(special order)***

+

(C) blu-stone™ vanity top + countertop
 View options, refer to page 24.

How to order 45° vanities:

Vanity frame SKU + finish/color code
 eg. UP series 900 vanity frame in White Matte (01M)
 lacquer finish = **F45V2-0900.1-01M**

+

Drawer front SKU + finish/color code
 eg. UP series 900 drawer front in Bromo Matte (68M)
 lacquer finish = **FV2D-0900.1-68M**

Stocked



natural oak 02

Special Order Finishes



vintage oak 03



distressed oak 04



olmo smoke 05



walnut 08



Rovere 09



white matte 01M
gloss 01G



black matte 04M
gloss 04G



efeso matte 62M
gloss 62G



bromo matte 68M
gloss 68G



ottawa matte 88M
gloss 88G



londra matte 90M
gloss 90G



jaipur matte 94M
gloss 94G



orinoco matte 96M
gloss 96G

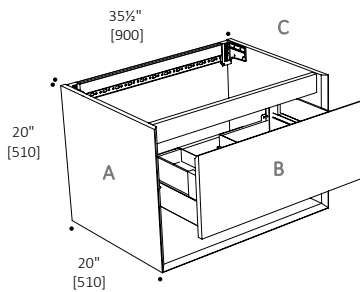

* special order finishes require 16 - 20 weeks lead time upon 50% deposit confirmation *

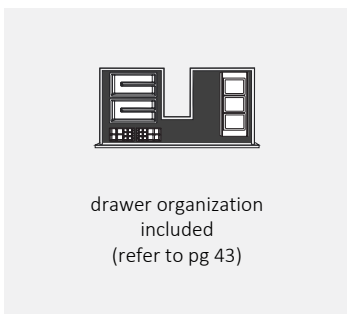

(A) F45V2-0900.1 + (B) FV2D-0900.1

- 35½" W × 20" H × 20" D / 900mm W x 510mm H x 510mm D
- Wall-mount vanity with single drawer + open bottom shelf
- The two lower angles feature a unique 45 degree join
- Drawer organization included: 2 storage compartments, 2 cosmetic holders + 1 storage bin set.
- Drawer designed for plumbing clearance
- Recessed integral finger pull channel with Hettich soft-close system
- Designed to coordinate with series 900 blu-stone™ vanity top basin or countertop
- Vanity frame available in a choice of Natural Oak (02) wood finish or White Matte (01M) lacquer; drawer fronts available in a range of wood and lacquer finishes + colors

(A) vanity frame

- F45V2-0900.1-01M (in stock)
- F45V2-0900.1-02* (special order)

+

(B) wood drawer front

- FV2D-0900.1-02 (in stock)
- FV2D-0900.1-03* (special order)
- FV2D-0900.1-04* (special order)
- FV2D-0900.1-05* (special order)
- FV2D-0900.1-08* (special order)
- FV2D-0900.1-09* (special order)

or

(B) lacquer drawer front

- FV2D-0900.1-01M / 04M / 62M / 68M / 88M / 90M / 94M / 96M* (special order)
- FV2D-0900.1 - 01G / 04G / 62G / 68G / 88G / 90G / 94G / 96G* (special order)

+

(C) blu-stone™ vanity top + countertop
View options, refer to page 24.

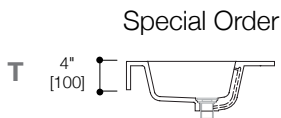
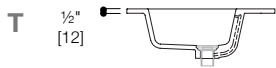
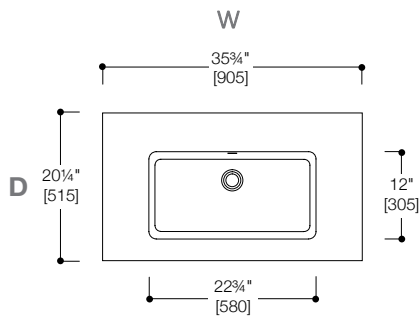

Top 35

SA0900.01-01M

(matte white)

(in stock)

SA0900.01-01G*

(gloss white)

(special order)

- 35 3/4" W x 20 1/4" D x 1/2" T / 905mm W x 515mm D x 12mm T
- blu-stone™ vanity top with integrated basin and integral slot overflow
- Basin: 18 3/4" W x 5" H x 12" D / 480mm W x 128mm H x 305mm D
- Knockouts may be drilled on-site for deck-mount faucet
- Includes matching blu-stone™ waste cover
- Available in a range of blu-stone™ colors + finishes
- Designed to coordinate with series 900 45° or 51 collection vanities
- Recommend QTW-0121 push button waste; designed for use with blu-stone™ waste cover or SC015 universal push button waste

Special Order Finishes

for 1/2" or 1" - 4" apron thickness:



*Special Order finishes require a 20+ week lead time

*Special Order finishes are Made to Order, non-returnable

*Any Sherwin Williams color is available without additional up-charge and based on 1 round of sample

* advise height when ordering

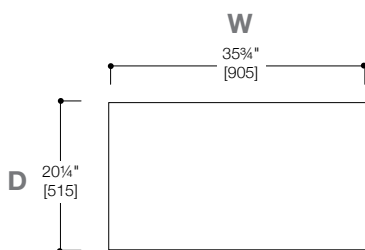

1/2" thickness

SAC0900.01-01M*

- 35 3/4" W x 20 1/4" D x 1/2" T / 905mm W x 515mm D x 12mm T
- blu-stone™ vanity countertop
- May be drilled on-site for deck-mount faucet installation
- Only available in White Matte finish
- Designed to coordinate with series 900 45° or 51 collection vanities

*Special Order finishes require a 20+ week lead time

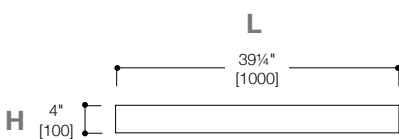

1/2" thickness

SABS1000.01-01M*

- 39 1/4" W x 4" H x 1/2" D / 1000mm W x 100mm H x 12mm D
- Seamless, blu-stone™ vanity backsplash
- Can be cut to fit on-site
- Only available in White Matte finish
- Coordinate with 45° or 51 collection vanities including: series 600 / 700 / 900

*Special Order finishes require a 20+ week lead time



45° collection series 1200 mirror F45M1-1200-02
blu-stone™ series 1200 vanity top basin SA1200.01-01M
45° collection series 1200 UP vanity frame F45V2-1200.1-01M + drawer front FV2D-1200.1-03 source series
deck faucet 1201-AS



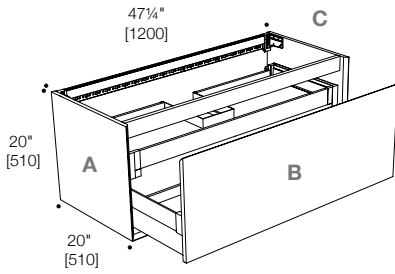

(A) F45V1-1200.1 + (B) FV1D-1200.1

- 47 1/4" W x 20" H x 20" D / 1200mm W x 510mm H x 510mm D
- Wall-mount vanity with deep drawer + slim drawer insert
- The two lower angles feature a unique 45 degree join
- Drawer organization included: 2 storage compartments, 4 cosmetic holders, 1 storage bin set + 1 tissue box.
- Slim inner drawer designed for plumbing clearance
- Recessed integral finger pull channel with Hettich soft-close system
- Designed to coordinate with series 1200 blu-stone™ vanity top or countertop
- Vanity frame available in a choice of Natural Oak (02) wood finish or White Matte (01M) lacquer; drawer fronts available in a range of wood and lacquer finishes + colors

* special order finishes require 16 - 20 weeks lead time upon 50% deposit confirmation *

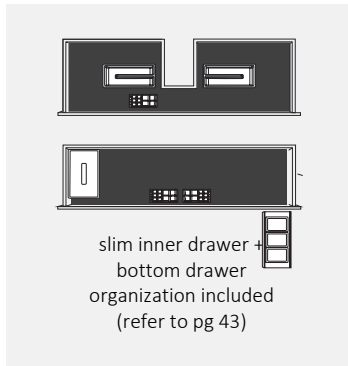

(A) vanity frame

- F45V1-1200.1-01M *(in stock)*
- F45V1-1200.1-02* *(special order)*

+

(B) wood drawer front

- FV1D-1200.1-02 *(in stock)*
- FV1D-1200.1-03* *(special order)*
- FV1D-1200.1-04* *(special order)*
- FV1D-1200.1-05* *(special order)*
- FV1D-1200.1-08* *(special order)*
- FV1D-1200.1-09* *(special order)*

or

(B) lacquer drawer front

- FV1D-1200.1-01M / 04M / 62M / 68M / 88M / 90M / 94M / 96M* *(special order)*
- FV1D-1200.1 - 01G / 04G / 62G / 68G / 88G / 90G / 94G / 96G* *(special order)*

+

(C) blu-stone™ vanity top + countertop

View options, refer to page 28.

45° furniture

How to order 45° vanities:

Vanity frame SKU + finish/color code
eg. UP series 1200 vanity frame in Natural Oak (02)
wood finish = **F45V2-1200.1-02**

+

Drawer front SKU + finish/color code
eg. UP series 1200 drawer front in Natural Oak (02)
wood finish = **FV2D-1200.1-02**

Stocked



natural oak 02

Special Order Finishes



vintage oak 03



distressed oak 04



olmo smoke 05



walnut 08



Rovere 09



white matte 01M
gloss 01G



black matte 04M
gloss 04G



efeso matte 62M
gloss 62G



bromo matte 68M
gloss 68G



ottawa matte 88M
gloss 88G



londra matte 90M
gloss 90G



jaipur matte 94M
gloss 94G



orinoco matte 96M
gloss 96G

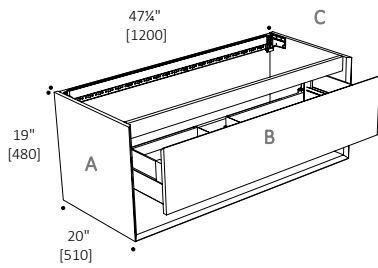

* special order finishes require 16 - 20 weeks lead time upon 50% deposit confirmation *



drawer organization included (refer to pg 43)

(A) F45V2-1200.1 + (B) FV2D-1200.1

- 47 1/4" W x 19" H x 20" D / 1200mm W x 480mm H x 510mm D
- Wall-mount vanity with single drawer + open bottom shelf
- The two lower angles feature a unique 45 degree join
- Drawer organization included: 2 storage compartments, 2 cosmetic holders + 1 storage bin set.
- Drawer designed for plumbing clearance
- Recessed integral finger pull channel with Hettich soft-close system
- Designed to coordinate with series 1200 blu-stone™ vanity top or countertop
- Vanity frame available in a choice of Natural Oak (02) wood finish or White Matte (01M) lacquer; drawer fronts available in a range of wood and lacquer finishes + colors

(A) vanity frame

- F45V2-1200.1-01M *(in stock)*
- F45V2-1200.1-02* *(special order)*

+

(B) wood drawer front

- FV2D-1200.1-02 *(in stock)*
- FV2D-1200.1-03* *(special order)*
- FV2D-1200.1-04* *(special order)*
- FV2D-1200.1-05* *(special order)*
- FV2D-1200.1-08* *(special order)*
- FV2D-1200.1-09* *(special order)*

or

(B) lacquer drawer front

- FV2D-1200.1-01M / 04M / 62M / 68M / 88M / 90M / 94M / 96M* *(special order)*
- FV2D-1200.1 - 01G / 04G / 62G / 68G / 88G / 90G / 94G / 96G* *(special order)*

+

(C) blu-stone™ vanity top + countertop
View options, refer to page 28

F45M1-1200 ** Limited Stock **

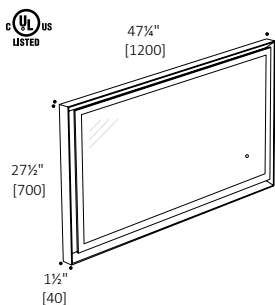

- 47 1/4" W x 27 1/2" H x 1 1/2" D / 1200mm W x 700mm H x 40mm D
- Framed mirror with soft LED perimeter lighting and touch sensor switch
- 110V strip LED 9.6 W/MT RV 4200K
- Unique 45 degree join on all four angles
- Frosted edging around mirror perimeter
- Mirror frame available in a choice of White Matte (01M) or Black Matte (04M) lacquer or Natural Oak (02) wood finish (refer to pgs 14-17 B) LED
- light strip 3000K is available can be replaced onsite
PT-F45M1-LED-STRIP-4

wood frame

F45M1-1200-02

lacquer frame

F45M1-1200-04M*

How to order 45° mirrors:

Mirror SKU + finish/color code

eg. series 1200 mirror in Natural Oak (02) wood finish = **F45M1-1200-02**

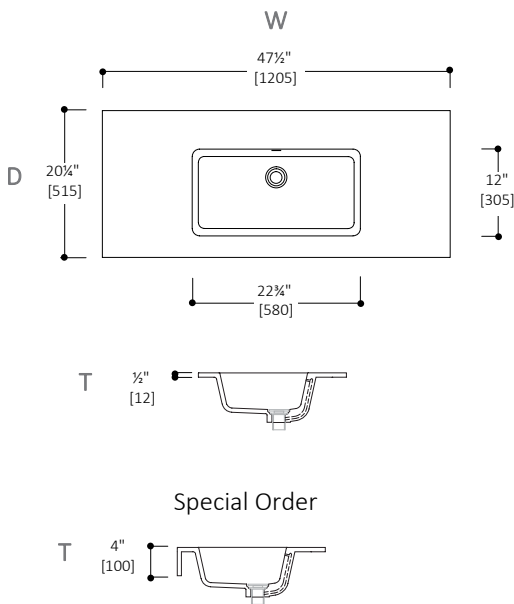

Top 47

SA1200.01-01M

(matte white)

(in stock)

SA1200.01-01G*

(gloss white)

(special order)

- 47½" W x 20¾" D x ½" T / 1205mm W x 515mm D x 12mm T
- blu-stone™ vanity top with integrated basin and integral slot overflow
- Basin: 22¾" W x 5" H x 12" D / 580mm W x 128mm H x 305mm D
- Knockouts may be drilled on-site for deck-mount faucet
- Includes matching blu-stone™ waste cover
- Available in a range of blu-stone™ colors + finishes
- Designed to coordinate with series 1200 45° or 51 collection vanities
- Recommend QTW-0121 push button waste; designed for use with blu-stone™ waste cover or SC015 universal push button waste

Special Order Finishes

for ½" or 1" - 4" apron thickness:



*Special Order finishes require a 20+ week lead time

*Special Order finishes are Made to Order, non-returnable

*Any Sherwin Williams color is available without additional up-charge and based on 1 round of sample

* advise height when ordering

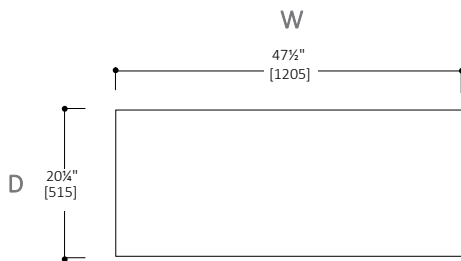

½" thickness

SAC1200.01-01M*

- 47½" W x 20¾" D x ½" T / 1205mm W x 515mm D x 12mm T
- blu-stone™ vanity countertop
- May be drilled on-site for deck-mount faucet installation
- Only available in White Matte finish
- Designed to coordinate with series 1200 45° or 51 collection vanities

*Special Order finishes require a 20+ week lead time

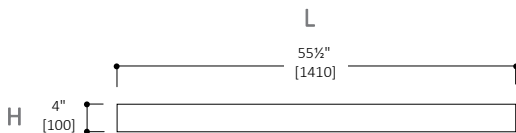

½" thickness

SABS1400.01-01M*

- 55½" W x 4" H x ½" D / 1410mm W x 100mm H x 12mm D
- Seamless, blu-stone™ vanity backsplash
- Can be cut to fit on-site
- Only available in White Matte finish
- Coordinate with 45° or 51 collection vanities including: series 1200 (to be cut on-site) / 1400

*Special Order finishes require a 20+ week lead time

blu-stone™ series 1400 vanity top basin SA1410.01-01M
blu-stone™ vanity backsplash SABS1400-01M valvola.02 series
deck mixer 2051-ON
deck spout BC302-ON



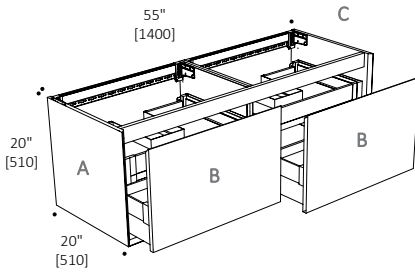

(A) F45V1-1400.1 + (B) FV1D-1400.1

- 55" W x 20" H x 20" D / 1400mm W x 510mm H x 510mm D
- Wall-mount double vanity with two deep drawers + slim drawer inserts
- The two lower angles feature a unique 45 degree joint
- Drawer organization included: 4 storage compartments, 4 cosmetic holders, 2 storage bin sets + 1 tissue box.
- Slim inner drawers designed for plumbing clearance
- Recessed integral finger pull channels with Hettich soft-close system
- Designed to coordinate with series 1400 blu-stone™ vanity top basin or countertop
- Vanity frame available in a choice of Natural Oak (02) wood finish or White Matte (01M) lacquer; drawer fronts available in a range of wood and lacquer finishes + colors

* special order finishes require 16 - 20 weeks lead time upon 50% deposit confirmation *

double vanity frame

- (A) F45V1-1400.1-01M** *(in stock)*
F45V1-1400.1-02* *(special order)*

+

wood drawer front x2

- (B) FV1D-1400.1-02** *(in stock)*
**FV1D-1400.1-03* *(special order)*
**FV1D-1400.1-04* *(special order)*
**FV1D-1400.1-05* *(special order)*
**FV1D-1400.1-08* *(special order)*
FV1D-1400.1-09* *(special order)*********

or

lacquer drawer front x2

- (B) FV1D-1400.1 - 01M / 04M / 62M / 68M / 88M / 90M / 94M / 96M*** *(special order)*
FV1D-1400.1 - 01G / 04G / 62G / 68G / 88G / 90G / 94G / 96G* *(special order)*

+

- (C) blu-stone™ vanity top + countertop View options, refer to pages 34-35**

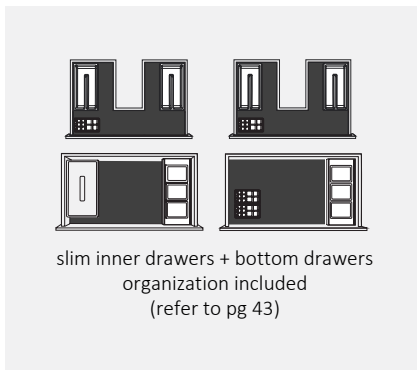

45° furniture

How to order 45° vanities:

Vanity frame SKU + finish/color code

eg. FULL series 1400 vanity frame in White Matte (01M) lacquer finish = **F45V1-1400.1-01M**

+

Drawer front SKU + finish/color code

eg. FULL series 1400 drawer fronts in Ottawa (88M) lacquer finish = **FV1D-1400.1-88M**

Stocked



natural oak 02

Special Order Finishes



vintage oak 03



distressed oak 04



olmo smoke 05



walnut 08



Rovere 09



white matte 01M
gloss 01G



black matte 04M
gloss 04G



efeso matte 62M
gloss 62G



bromo matte 68M
gloss 68G



ottawa matte 88M
gloss 88G



londra matte 90M
gloss 90G



jaipur matte 94M
gloss 94G



orinoco matte 96M
gloss 96G

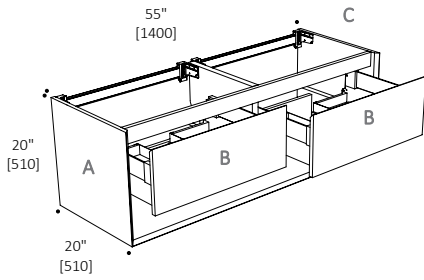

* special order finishes require 16 - 20 weeks lead time upon 50% deposit confirmation *



drawer organization included (refer to pg 43)

(A) F45V2-1400.1 + (B) FV2D-1400.1

- 55" W x 20" H x 20" D / 1400mm W x 510mm H x 510mm D
- Wall-mount double vanity with two single drawers + open bottom shelf
- The two lower angles feature a unique 45 degree join
- Drawer organization included: 2 storage compartments, 4 cosmetic holders + 2 storage bin sets.
- Drawers designed for plumbing clearance
- Recessed integral finger pull channels with Hettich soft-close system
- Designed to coordinate with series 1400 blu-stone™ vanity top basin or countertop
- Vanity frame available in a choice of Natural Oak (02) wood finish or White Matte (01M) lacquer; drawer fronts available in a range of wood and lacquer finishes + colors.

(A) double vanity frame

- F45V2-1400.1-01M *(in stock)*
- F45V2-1400.1-02* *(special order)*

+

(B) wood drawer front x2

- FV2D-1400.1-02 *(in stock)*
- FV2D-1400.1-03* *(special order)*
- FV2D-1400.1-04* *(special order)*
- FV2D-1400.1-05* *(special order)*
- FV2D-1400.1-08* *(special order)*
- FV2D-1400.1-09* *(special order)*

OR

(B) lacquer drawer front x2

- FV2D-1400.1-01M/04M/62M/68M/88M/90M/94M/96M* *(special order)*
- FV2D-1400.1-01G/04G/62G/68G/88G/90G/94G/96G* *(special order)*

+

(C) blu-stone™ vanity top + countertop View options, refer to pages 32-33

F45M1-1400 ** Limited Stock **

- 55" W x 27½" H x 1½" D / 1400mm W x 700mm H x 40mm D Framed mirror with soft LED perimeter lighting and touch sensor switch
 - 110V strip LED 9.6 W/MT RV 4200K
 - Unique 45 degree join on all four angles
 - Frosted edging around mirror perimeter
 - Mirror frame available in a choice of White Matte (01M) or Black Matte (04M) lacquer or Natural Oak (02) wood finish (refer to pgs 14-17 B) LED
 - light strip 3000K is available can be replaced onsite
- PT-F45M1-LED-STRIP-4

lacquer frame

- F45M1-1400-01M
- F45M1-1400-04M*

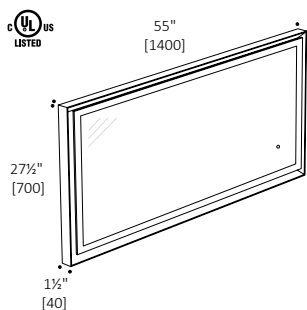

How to order 45° mirrors:

Mirror SKU + finish/color code

eg. series 1400 mirror in White Matte (01M) lacquer finish = **F45M1-1400-01M**

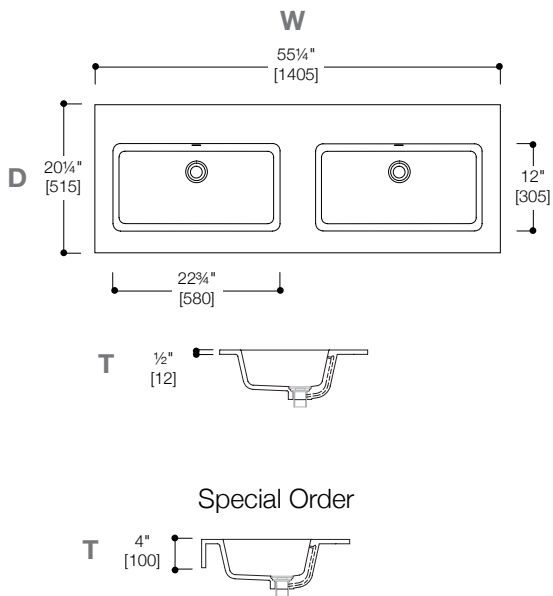

Top 55

SA1400.01-01M (matte white) (in stock)
 SA1400.01-01G* (gloss white) (special order)

- 55 1/4" W x 20 1/4" D x 1/2" T / 1405mm W x 515mm D x 12mm T
- blu-stone™ double vanity top with integrated basins and integral slot overflows
- Basins: 22 3/4" W x 5" H x 12" D / 580mm W x 128mm H x 305mm D
- Knockouts may be drilled on-site for deck-mount faucet
- Includes matching blu-stone™ waste covers
- Only available in White Matte or White Gloss finish
- Designed to coordinate with series 1400 45° or 51 collection vanities
- Recommend QTW-0121 push button waste; designed for use with blu-stone™ waste cover or SC015 universal push button waste (refer to pg 31 A)

Special Order Finishes

for 1/2" or 1" - 4" apron thickness:



*Special Order finishes require a 20+ week lead time
 *Special Order finishes are Made to Order, non-returnable
 *Any Sherwin Williams color is available without additional up-charge and based on 1 round of sample

* advise height when ordering

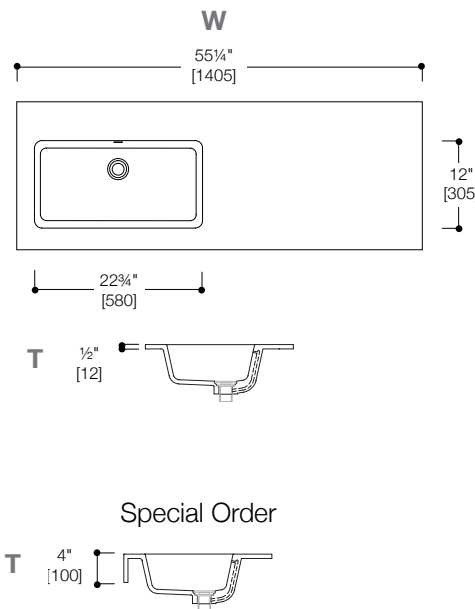

Top 55L

SA1401.01-01M (matte white) (in stock)
 SA1401.01-01G* (gloss white) (special order)

- 55 1/4" W x 20 1/4" D x 1/2" T / 1405mm W x 515mm D x 12mm T
- blu-stone™ vanity top with integrated left offset basin and integral slot overflow
- Basin: 22 3/4" W x 5" H x 12" D / 580mm W x 128mm H x 305mm D
- Knockouts may be drilled on-site for deck-mount faucet
- Includes matching blu-stone™ waste cover
- Only available in White Matte or White Gloss finish
- Designed to coordinate with series 1400 45° or 51 collection vanities
- Recommend QTW-0121 push button waste; designed for use with blu-stone™ waste cover or SC015 universal push button waste

Special Order Finishes

for 1/2" or 1" - 4" apron thickness:



*Special Order finishes require a 20+ week lead time
 *Special Order finishes are Made to Order, non-returnable
 *Any Sherwin Williams color is available without additional up-charge and based on 1 round of sample

* advise height when ordering



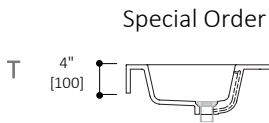
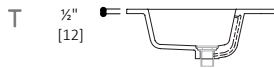
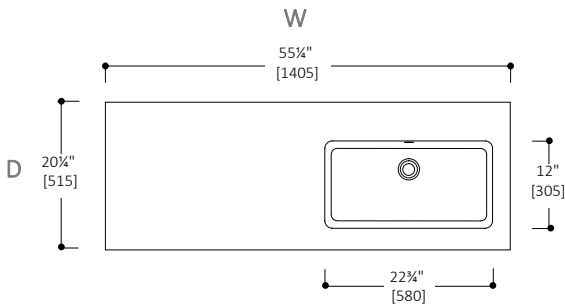

Top 55R

SA1402.01-01M
SA1402.01-01G*

(matte white)
(gloss white)

(in stock)
(special order)

- 55 1/4" W x 20 1/4" D x 1/2" T / 1405mm W x 515mm D x 12mm T
- blu-stone™ vanity top with integrated right offset basin and integral slot overflow
- Basin: 22 1/4" W x 5" H x 12" D / 580mm W x 128mm H x 305mm D
- Knockouts may be drilled on-site for deck-mount faucet
- Includes matching blu-stone™ waste cover
- Only available in White Matte or White Gloss finish
- Designed to coordinate with series 1400 45° or 51 collection vanities
- Recommend QTW-0121 push button waste; designed for use with blu-stone™ waste cover or SC015 universal push button waste

Special Order Finishes

for 1/2" or 1" - 4" apron thickness:



- *Special Order finishes require a 20+ week lead time
- *Special Order finishes are Made to Order, non-returnable
- *Up-charge and based on 1 round of sample
- *advise height when ordering

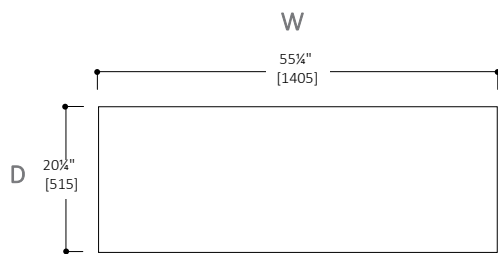

1/2" thickness

SAC1400.01-01M*

- 55 1/4" W x 20 1/4" D x 1/2" T / 1405mm W x 515mm D x 12mm T
- blu-stone™ vanity countertop
- May be drilled on-site for deck-mount faucet installation
- Only available in White Matte finish
- Designed to coordinate with series 1400 45° or 51 collection vanities

*Special Order finishes require a 20+ week lead time

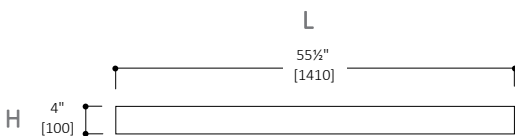

1/2" thickness

SABS1400.01-01M*

- 55 1/2" W x 4" H x 1/2" D / 1410mm W x 100mm H x 12mm D
- Seamless, blu-stone™ vanity backsplash
- Can be cut to fit on-site
- Only available in White Matte finish
- Coordinate with 45° or 51 collection vanities including: series 1200 (to be cut on-site) / 1400

*Special Order finishes require a 20+ week lead time

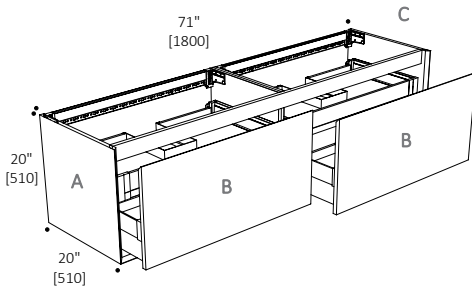

(A) F45V1-1800.1 + (B) FV1D-1800.1

- 71" W x 20" H x 20" D / 1800mm W x 510mm H x 510mm D
- Wall-mount double vanity with two deep drawers + slim drawer inserts
- The two lower angles feature a unique 45 degree join
- Drawer organization included: 4 storage compartments, 8 cosmetic holders, 4 storage bin sets + 1 tissue box.
- Slim inner drawers designed for plumbing clearance
- Recessed integral finger pull channels with Hettich soft-close system
- Designed to coordinate with series 1800 blu-stone™ vanity top basin or countertop
- Vanity frame available in a choice of Natural Oak (02) wood finish or White Matte (01M) lacquer; drawer fronts available in a range of wood and lacquer finishes + colors

* special order finishes require 16 - 20 weeks lead time upon 50% deposit confirmation *

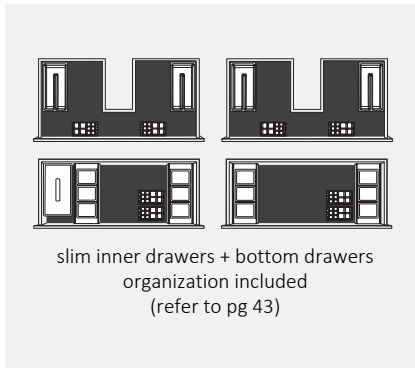

(A) double vanity frame

F45V1-1800.1-01M *(in stock)*
 F45V1-1800.1-02* *(special order)*

+

(B) wood drawer front x2

FV1D-1800.1-02 *(in stock)*
 FV1D-1800.1-03* *(special order)*
 FV1D-1800.1-04* *(special order)*
 FV1D-1800.1-05* *(special order)*
 FV1D-1800.1-08* *(special order)*
 FV1D-1800.1-09* *(special order)*

or

lacquer drawer front x2

(B) FV1D-1800.1-01M / 04M / 62M / 68M / 88M / 90M / 94M / 96M* *(special order)*
 FV1D-1800.1 - 01G / 04G / 62G / 68G / 88G / 90G / 94G / 96G* *(special order)*

+

(C) blu-stone™ vanity top + countertop View options, refer to pages 36-37

How to order 45° vanities:

Vanity frame SKU + finish/color code
 eg. UP series 1800 vanity frame in Natural Oak (02)
 wood finish = F45V2-1800.1-02

+

Drawer front SKU + finish/color code
 eg. UP series 1800 drawer fronts in Vintage Oak (03)
 wood finish = FV2D-1800.1-03

Stocked



natural oak 02

Special Order Finishes



vintage oak 03



distressed oak 04



olmo smoke 05



walnut 08



Rovere 09



white matte 01M
gloss 01G



black matte 04M
gloss 04G



efeso matte 62M
gloss 62G



bromo matte 68M
gloss 68G



ottawa matte 88M
gloss 88G



londra matte 90M
gloss 90G



jaipur matte 94M
gloss 94G



orinoco matte 96M
gloss 96G

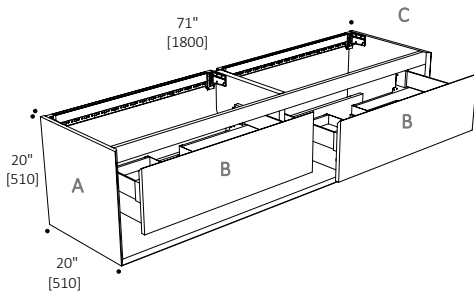

* special order finishes require
16 - 20 weeks lead time upon
50% deposit confirmation *

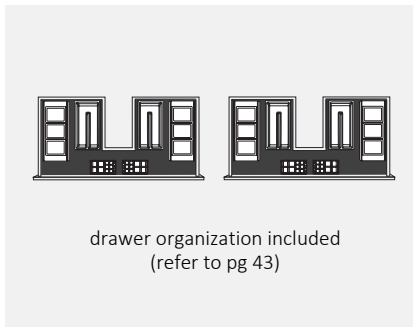

(A) F45V2-1800.1 + (B) FV1D-1800.1

- 71" W x 20" H x 20" D / 1800mm W x 510mm H x 510mm D
- Wall-mount double vanity with two single drawers + open bottom shelf
- The two lower angles feature a unique 45 degree join
- Drawer organization included: 4 storage compartments, 4 cosmetic holders + 4 storage bin sets.
- Drawers designed for plumbing clearance
- Recessed integral finger pull channel with Hettich soft-close system
- Designed to coordinate with series 1800 blu-stone™ vanity top basin or countertop
- Vanity frame available in a choice of Natural Oak (02) wood finish or White Matte (01M) lacquer; drawer fronts available in a range of wood and lacquer finishes + colors

(A) double vanity frame

F45V2-1800.1-01M *(in stock)*
F45V2-1800.1-02* *(special order)*

+

(B) wood drawer front x2

FV2D-1800.1-02 *(in stock)*
FV2D-1800.1-03* *(special order)*
FV2D-1800.1-04* *(special order)*
FV2D-1800.1-05* *(special order)*
FV2D-1800.1-08* *(special order)*
FV2D-1800.1-09* *(special order)*

or

(B) lacquer drawer front x2

FV2D-1800.1-01M/04M/62M/68M/88M/90M/94M/96M* *(special order)*
FV2D-1800.1-01G/04G/62G/68G/88G/90G/94G/96G* *(special order)*

+

(C) blu-stone™ vanity top+countertop View options, refer to pages 36-37

F45M1-1800 ** Limited Stock **

- 71" W x 27½" H x 1½" D / 1800mm W x 700mm H x 40mm D
- Framed double mirror with soft LED perimeter lighting and two touch sensor switches
- 110V strip LED 9.6 W/MT RV 4200K
- Unique 45 degree join on all four angles
- Frosted edging around mirror perimeter and vertically through center
- Mirror frame available in a choice of White Matte (01M) or Black Matte (04M) lacquer or Natural Oak (02) wood finish.
- LED light strip 3000K is available can be replaced onsite
- 2x PT-F45M1-LED-STRIP-3

wood frame

F45M1-1800-02

lacquer frame

F45M1-1800-01M

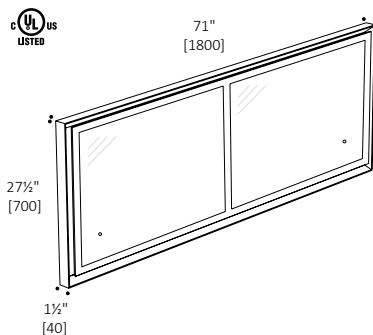

How to order 45° mirrors:

Mirror SKU + finish/color code

eg. series 1800 mirror in Natural Oak (02) wood finish = **F45M1-1800-02**

Top 71

SA1800.01-01M
SA1800.01-01G*

(matte white)

(in stock)

(gloss white)

(special order)

- 71" W x 20¼" D x ½" T / 1805mm W x 515mm D x 12mm T
- blu-stone™ double vanity top with integrated basins and integral slot overflows
- Basins: 22¾" W x 5" H x 12" D / 580mm W x 128mm H x 305mm D
- Knockouts may be drilled on-site for deck-mount faucet
- Includes matching blu-stone™ waste covers
- Only available in White Matte or White Gloss finish
- Designed to coordinate with series 1800 45° or 51 collection vanities.
- Recommend QTW-0121 push button waste; designed for use with blu-stone™ waste cover or SC015 universal push button waste

Special Order Finishes

for ½" or 1" - 4" apron thickness:



*Special Order finishes require a 20+ week lead time

*Special Order finishes are Made to Order, non-returnable

*Any Sherwin Williams color is available without additional up-charge and based on 1 round of sample

* advise height when ordering

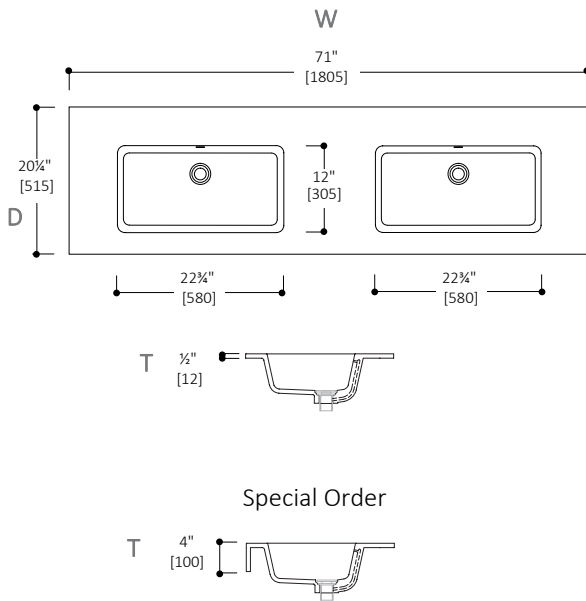

Top 71L

SA1801.01-01M
SA1801.01-01G*

(matte white)

(in stock)

(gloss white)

(special order)

- 71" W x 20¼" D x ½" T / 1805mm W x 515mm D x 12mm T
- blu-stone™ double vanity top with integrated basins and integral slot overflows
- Basins: 22¾" W x 5" H x 12" D / 580mm W x 128mm H x 305mm D
- Knockouts may be drilled on-site for deck-mount faucet
- Includes matching blu-stone™ waste covers
- Only available in White Matte or White Gloss finish
- Designed to coordinate with series 1800 45° or 51 collection vanities.
- Recommend QTW-0121 push button waste; designed for use with blu-stone™ waste cover or SC015 universal push button waste

Special Order Finishes

for ½" or 1" - 4" apron thickness:



*Special Order finishes require a 20+ week lead time

*Special Order finishes are Made to Order, non-returnable

*Any Sherwin Williams color is available without additional up-charge and based on 1 round of sample

* advise height when ordering

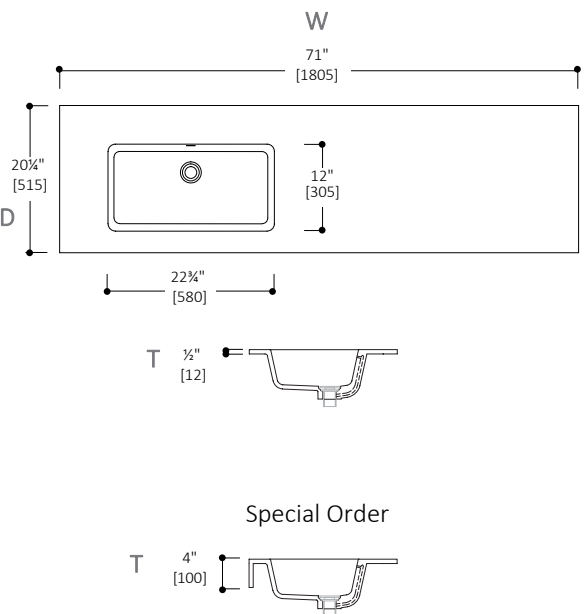

Top 71R

SA1802.01-01M*

(matte white)

(in stock)

SA1802.01-01G*

(gloss white)

(special order)

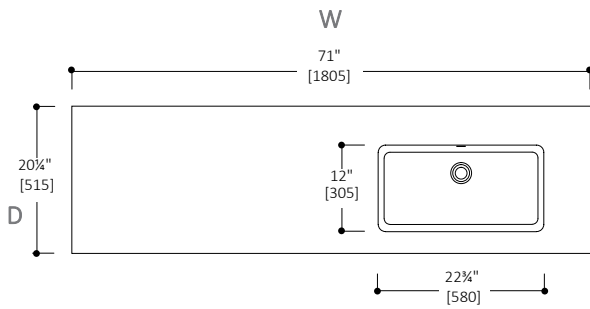

- 71" W x 20 1/4" D x 1/2" T / 1805mm W x 515mm D x 12mm T
- blu-stone™ vanity top with integrated right offset basin and integral slot overflow
- Basins: 22 3/4" W x 5" H x 12" D / 580mm W x 128mm H x 305mm D
- Knockouts may be drilled on-site for deck-mount faucet
- Includes matching blu-stone™ waste covers
- Only available in White Matte or White Gloss finish
- Designed to coordinate with series 1800 45° or 51 collection vanities
- Recommend QTW-0121 push button waste; designed for use with blu-stone™ waste cover or SC015 universal push button waste

Special Order Finishes

for 1/2" or 1" - 4" apron thickness:



*Special Order finishes require a 20+ week lead time

*Special Order finishes are Made to Order, non-returnable

*Any Sherwin Williams color is available without additional up-charge and based on 1 round of sample

* advise height when ordering

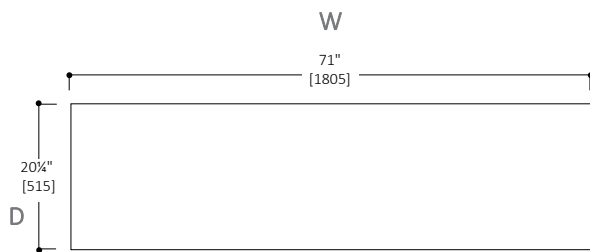
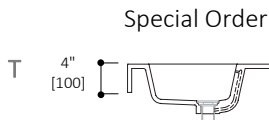

1/2" thickness

SAC1800.01-01M*

- 71" W x 20 1/4" D x 1/2" T / 1805mm W x 515mm D x 12mm T
- blu-stone™ vanity countertop
- May be drilled on-site for deck-mount faucet installation
- Only available in White Matte finish
- Designed to coordinate with series 1800 45° or 51 collection vanities

*Special Order finishes require a 20+ week lead time

1/2" thickness

SABS1800.01-01M*

- 71 1/4" W x 4" H x 1/2" D / 1810mm W x 100mm H x 12mm D
- Seamless, blu-stone™ vanity backsplash
- Can be cut to fit on-site
- Only available in White Matte finish
- Coordinate with 45° or 51 collection vanities including: series 1800

*Special Order finishes require a 20+ week lead time

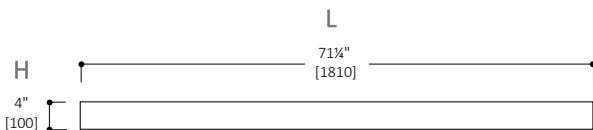

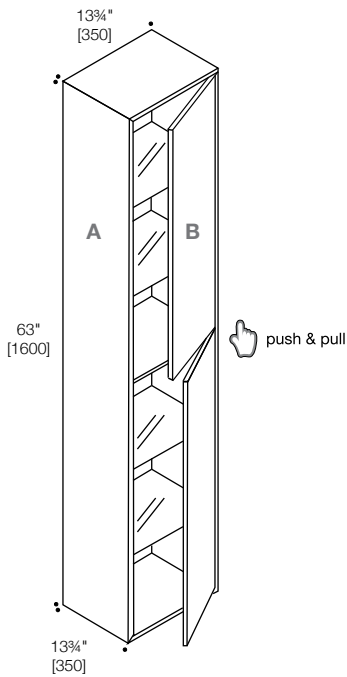

* special order finishes require 16 - 20 weeks lead time upon 50% deposit confirmation *

(A) F45W1-1600 + (B) FW1D-1600

- 13 3/4" W x 63" H x 13 3/4" D / 350mm W x 1600mm H x 350mm D
- Wall-mount bathroom cabinet with shelving + individual top & bottom doors
- Frame is designed for left or right hand door installation
- Shelving includes: 4 glass + 1 wood
- Push/pull opening system
- Unique 45 degree join on all four angles
- Cabinet frame available in a choice of Natural Oak (02) wood finish or White Matte (01M) lacquer; door fronts available in a range of wood and lacquer finishes + colors

(A) cabinet frame

- F45W1-1600-01M *(in stock)*
- F45W1-1600-02* *(special order)*

+

(B) wood door fronts

- FW1D-1600-02 *(in stock)*
- FW1D-1600-03* *(special order)*
- FW1D-1600-04* *(special order)*
- FW1D-1600-05* *(special order)*
- FW1D-1600-08* *(special order)*
- FW1D-1600-09* *(special order)*

or

lacquer door fronts

- (B)** FW1D-1600 - 01M / 04M / 62M / 68M / 88M / 90M / 94M / 96M* *(special order)*
 FW1D-1600 - 01G / 04G / 62G / 68G / 88G / 90G / 94G / 96G* *(special order)*

How to order a 45° wall cabinet:

Cabinet frame SKU + finish/color code eg.
 cabinet frame in white matte (01M) lacquer
 finish = **F45W1-1600-01M**

+

Door front SKU + finish/color code eg.
 door front in Natural Oak (02) wood
 finish = **FW1D-1600-02**

Stocked



natural oak 02

Special Order Finishes



vintage oak 03



distressed oak 04



olmo smoke 05



walnut 08



Rovere 09



white matte 01M
gloss 01G



black matte 04M
gloss 04G



efeso matte 62M
gloss 62G



bromo matte 68M
gloss 68G



ottawa matte 88M
gloss 88G



londra matte 90M
gloss 90G



jaipur matte 94M
gloss 94G



orinoco matte 96M
gloss 96G



45° collection cabinet frame F45W1-1600-01M + cabinet door front FW1D-1600-02

51 collection series 1200 frameless mirror F51M2-1200

45° collection series 1200 FULL vanity frame F45V1-1200.1-01M + drawer front FV1D-1200.1-02 blu-stone™
series 1200 vanity top basin SA1200.01-01M

source series deck faucet 1203-AS

SC015

- Universal push button waste,
- Suitable for both overflow and no overflow applications
- Shrouded threads + tailpiece included with waste
- Stainless steel AISI316L

finish

- AS
- ON*
- OC*

*Finishes: ON, OC are Special Order items and require a 6-8 week lead time upon order confirmation

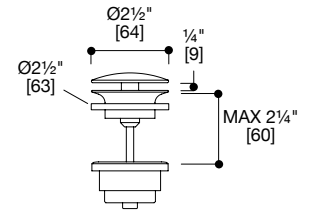

QTW-0120

- Push button waste without overflow
- Shrouded threads + tailpiece included with waste
- Stainless steel AISI316L
- Designed for use with blu·stone™ waste cover

finish

- AS

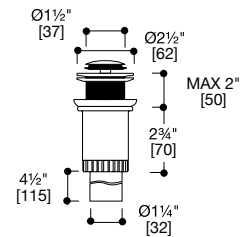

QTW-0121

- Push button waste with overflow
- Shrouded threads + tailpiece included with waste
- Stainless steel AISI316L
- Designed for use with blu·stone™ waste cover

finish

- AS

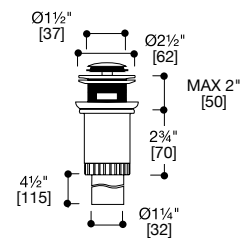



F01AC-01

- Kit includes 2 storage compartments, suitable for all 45°, 45° FENIX™ and 51 vanities
- Individual Storage Compartment:
10½" L x 5½" W x 1¾" H / 269mm L x 139mm W x 42mm H
- Ideal for organizing make-up brushes and other beauty accessories



F01AC-02

- Kit includes 2 cosmetic holders, suitable for all 45°, 45° FENIX™ and 51 vanities
- Individual Cosmetic Holder:
5½" L x 2¾" W x 1½" H / 139mm L x 73mm W x 41mm H
- Ideal for organizing nail polishes, lipsticks, beauty pencils and other small items



F01AC-03

- Kit includes 2 storage bin sets, suitable for all 45°, 45° FENIX™ and 51 vanities
- Individual Storage Bin:
13¾" L x 5¾" W x 2¾" H / 334mm L x 146mm W x 41mm H
- Ideal for storing jewelry, cotton balls and other essentials



F01AC-04

- Kit includes 1 tissue box, suitable for all 45°, 45° FENIX™ and 51 vanities
- Tissue Box:
11¼" L x 6¼" W x 3½" H / 286mm L x 156mm W x 90mm H



F45AC-01

- Drawer filler designed to slot into the slim inner drawer of series 1400 + 1800 45° and 45° FENIX™ collection vanites
- Provides additional storage space when plumbing clearance is not required
- Drawer filler:
7¼" W x 2¼" H x 10" D / 182mm W x 59mm H x 251mm D

45°

FENIX™

furniture collection

vanities
mirror
cabinet



45° FENIX™ collection series 1400 FULL vanity frame FXV1-1402-04M + drawer fronts FV1D-1400.1-04

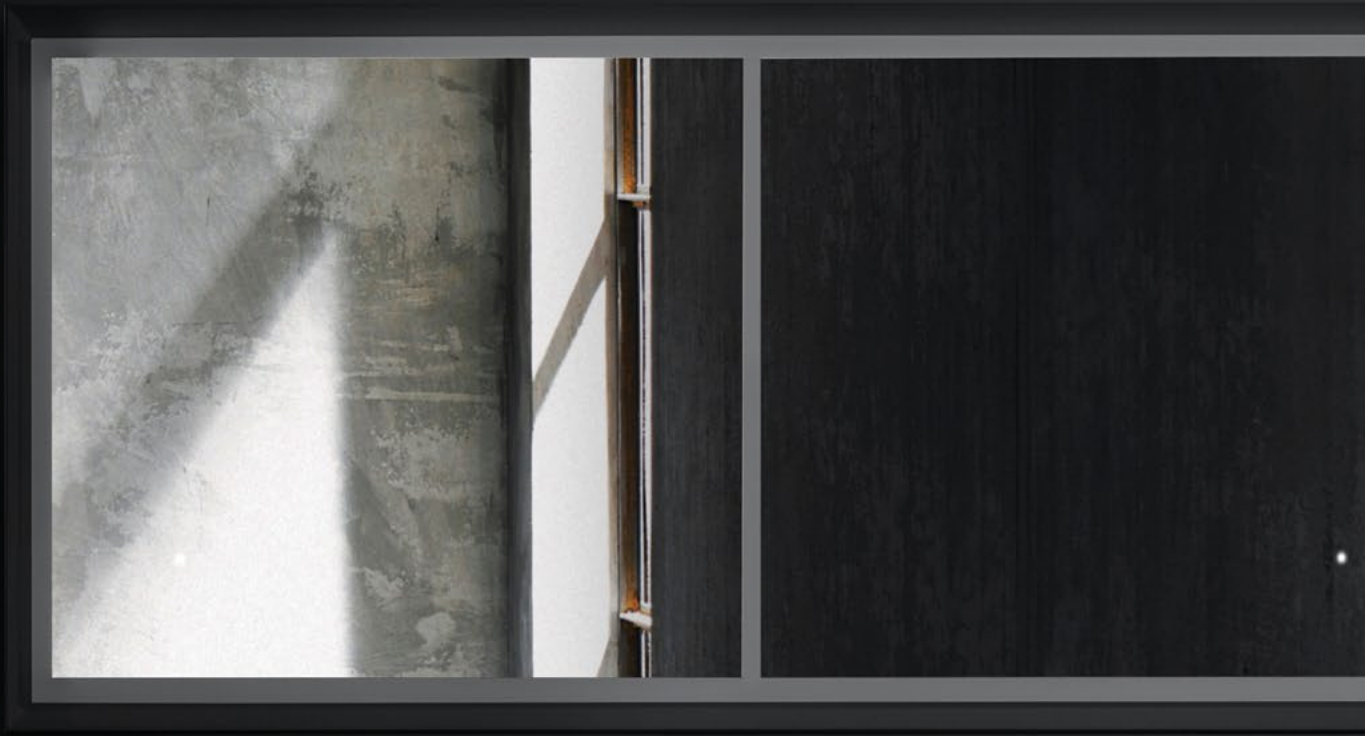

45° FENIX™ collection series 900 FULL vanity frame FXV2-0900-04M + drawer front FV2D-0900.1-04 source series deck faucet 1201-AS



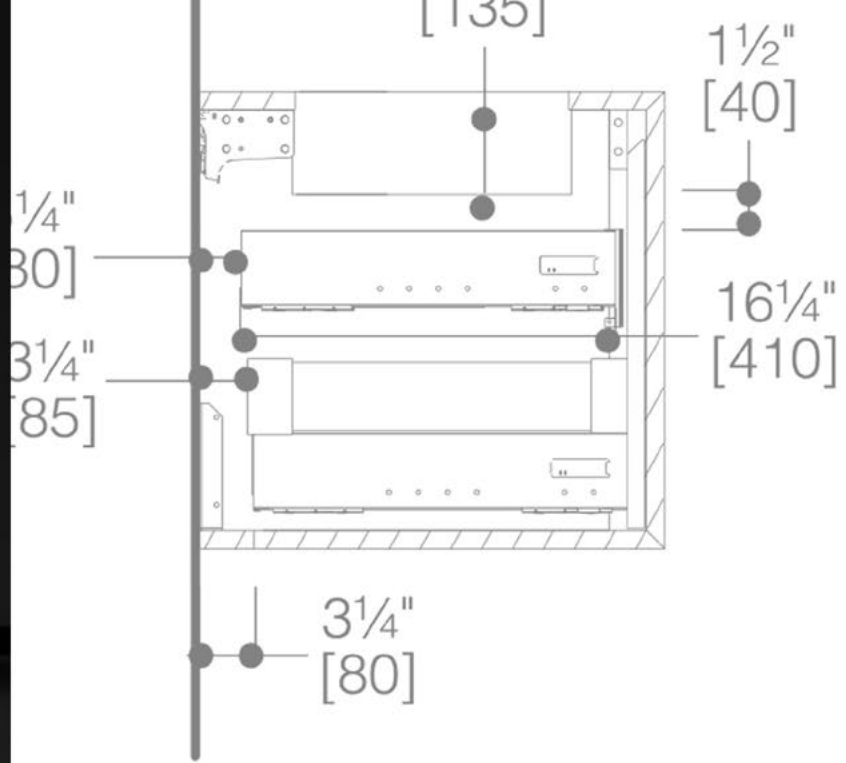

SIDE VIEW

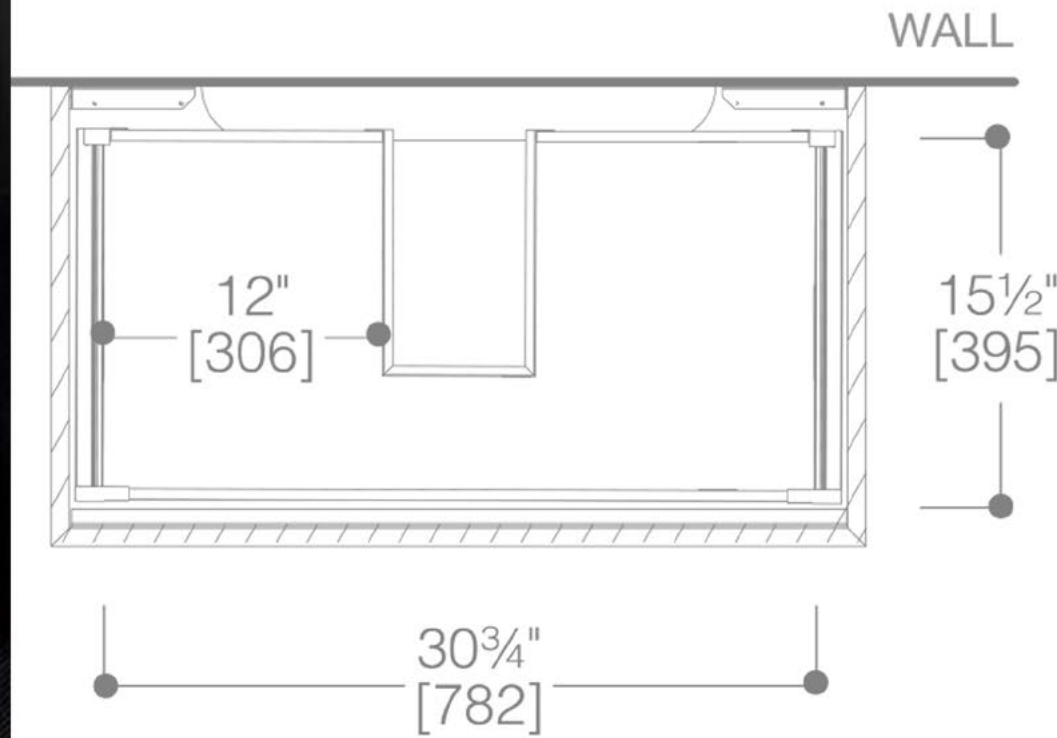

TOP DRAWER VIEW



51 collection series 1800 frameless mirror F51M2-1800

45° FENIX™ collection series 1800 FULL vanity frame FXV1-1800-01M + drawer fronts FV1D-1800.1-01M source series
deck faucets 1201-AS



45° FENIX™ collection series 1400 FULL vanity frame FXV1-1400-04M + drawer fronts FV1D-1400.1-09

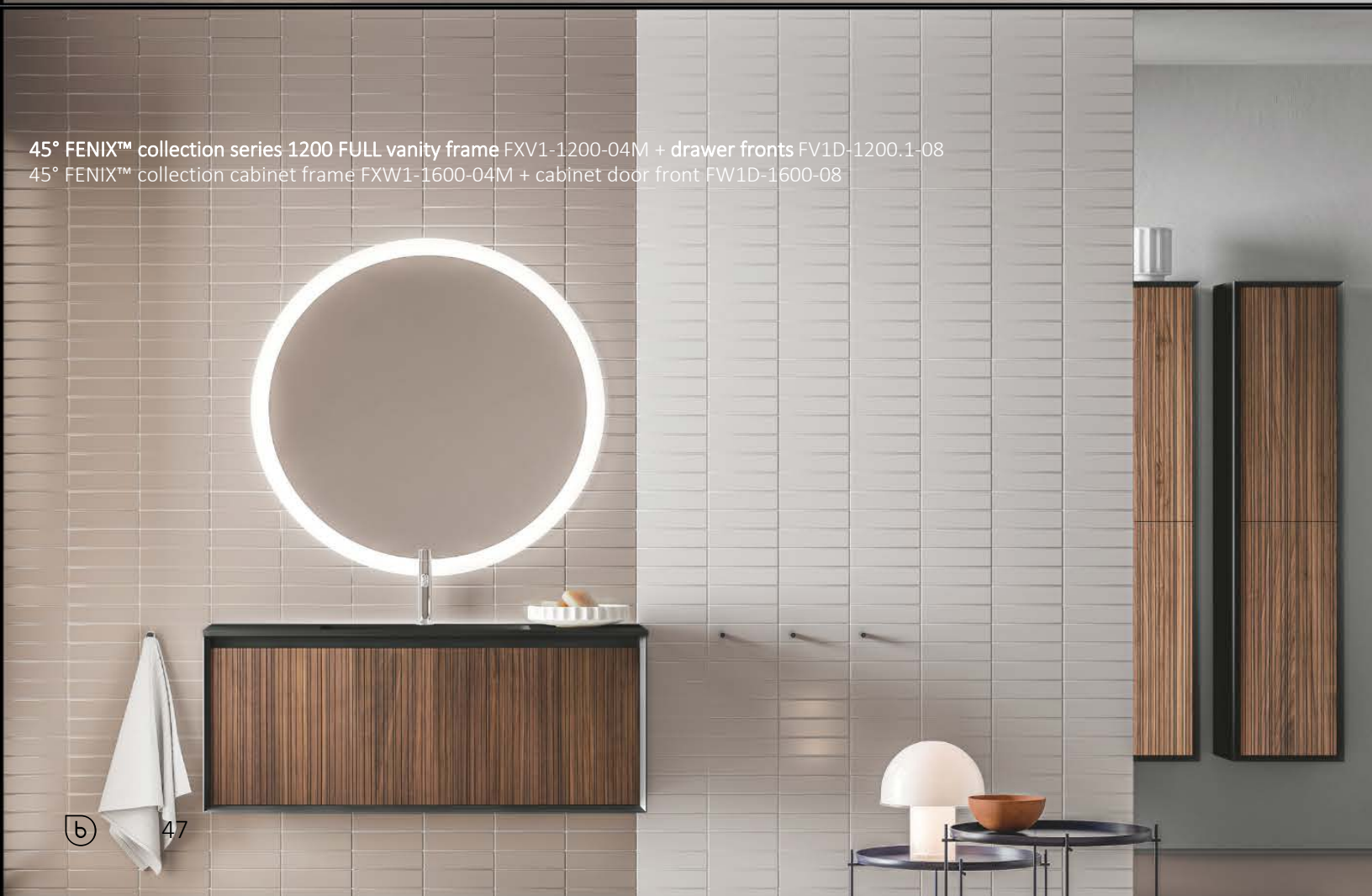

45° FENIX™ collection series 1200 FULL vanity frame FXV1-1200-04M + drawer fronts FV1D-1200.1-08

45° FENIX™ collection cabinet frame FXW1-1600-04M + cabinet door front FW1D-1600-08

features + benefits

Blu Bathworks 45° + FENIX™ furniture collection, stands out by its unique 45 degree design feature, integrated basin with the latest generation of technological finish material - FENIX™. The collection is designed as a modular range of wall-mount vanities from 27½" to 71" wide, with coordinating 45° collection mirrors with LED lighting.



Unique 45° Design Feature

The entire 45° FENIX™ furniture collection is characterized by a unique 45 degree design feature, which is found in the joints of the structure and in the sloping cut of the top of the fronts which creates a practical and elegant opening system. This design feature is also evident on all four angles of the mirror frames – and serves to further elevate the quality craftsmanship inherent in this collection.



Vanity Design Options

45° FENIX™ collection offers two vanity design options: FULL features a slim inner drawer within a drawer design, which provides quick & easy access to smaller items, while facilitating a clean, minimalist look externally. UP vanity design provides a single drawer with an open bottom shelf to store and display towels and other toiletries.



Integrated Basin

45° FENIX™ vanities have integrated basins in FENIX™ finish with central matching drain. This vanity will demand attention from anyone who sees it, becoming the centerpiece of your modern bathroom.

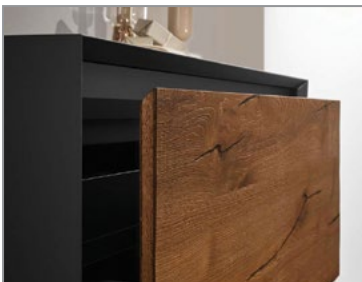

Hettich Soft-Close System

Promoting a minimalist, handle-free aesthetic, all 45° FENIX™ vanities feature a recessed finger pull channel to easily open the drawer, while Hettich technology is incorporated to provide a smooth, soft-close operation every time.



45° collection Mirror with LED Lighting

An LED perimeter light, subtly positioned behind the frosted edging, is standard with each 45° collection mirror - omitting a soft glow (color temperature: 4200K). Lighting is operated by a discreet ¼" touch sensor switch, located on the mirror face. Mirrors are available in a matte white or black lacquer finish to coordinate with 45° FENIX™ vanities.



Plumbing Clearance Drawer Design

The slim drawer within a drawer design of 45° FENIX™ vanities provide quick & easy access to smaller items, while facilitating a clean, minimalist look externally. Vanity drawers are designed to maximize storage space while separating stored items from plumbing drain pipes.



Vanity Drawer Organization is Standard

To facilitate bathroom organization, each 45° FENIX™ vanity is equipped with a range of storage compartments, bins + cosmetic holders. Drawer organization kits are also available separately for additional custom storage requirements.

Quick & Easy Installation

Great care has been taken in the design of 45° FENIX™ vanities and 45° collection mirrors to ensure convenient installation, including an integral channel on the backside of each mirror to allow the installer to adjust brackets to hit studs accordingly. Similarly, all 45° FENIX™ vanities are equipped with one continuous bracket along the backside to allow easy retro-fitting / hitting studs where backing or additional support is not available.

finish + color guide

45° FENIX™ FULL VANITY

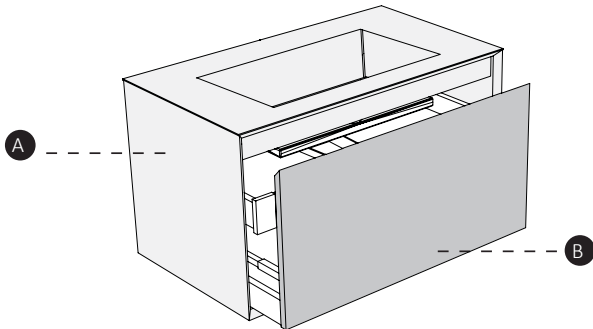

DESIGN OPTION: V1

45° FENIX™ UP VANITY

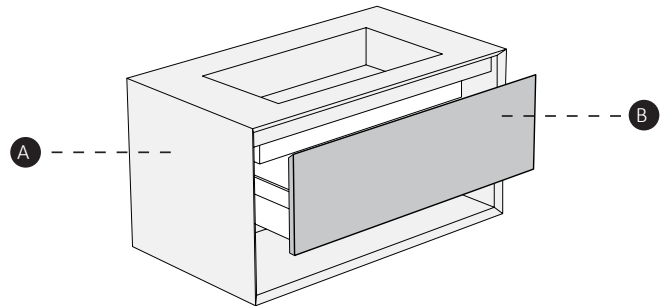

DESIGN OPTION: V2

Materials:

A vanity frame

FENIX™

An innovative Nanotech material: a smart surface, extremely matte, fingerprint proof, soft to the touch but resistant to rubbing, abrasions, impacts, and thermally self-heals micro-scratches.

B vanity drawer front

Wood - Natural Oak

Constructed of real massif wood and wood veneer finish

Wood - Vintage Oak

Wood veneer on a multi layer birch wood panel

Wood - Distressed Oak

Solid wood multi layer oak

Wood - Olmo

Wood veneer with vertical slats and light brushing to enhance the grain, mounted on a solid multi-layer birch wood panel.

Wood – Walnut & Rovere

Natural oak and walnut veneers with design engravings on black MDF

Lacquer

Engineered wood (MDF) panel IDROLEB

Note: Wood is a natural product, therefore any variations in color, vein or finish are considered part of the wood's value and craftsmanship. Wood is a material that has its uniqueness and originality. For this characteristic, differences in grain and color tones can be found, which fall within the tolerances provided by the standards and which make each front unique.

How to order 45° FENIX™ vanities:

A Vanity frame SKU + furniture finish/color code

+ eg. FULL series 900 vanity frame in White Matte (01M) FENIX™ finish = **FXV1-0900-01M**

B Drawer front SKU + furniture finish/color code

eg. FULL series 900 drawer front in Natural Oak (02) wood finish = **FV1D-0900.1-02**

FENIX™ + WOOD

Please refer to furniture sample chips for true finish and color.

45° FENIX™ vanity frame + drawer front special order*

(Max 50% discount)

black matte

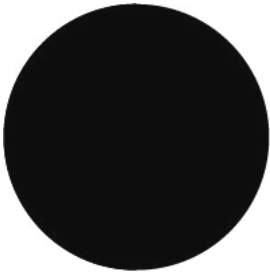

04M

white matte



01M

45° FENIX™ vanity drawer front special order*

(Max 50% discount)

natural oak



02

vintage oak



03

distressed oak



04

olmo smoke



05

walnut



08

rovere

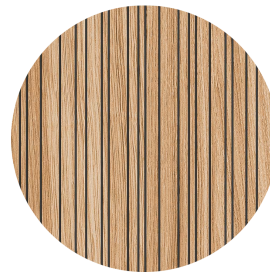

09

LACQUER

Please refer to furniture sample chips for true finish and color.

45° vanity drawer front

special order*

(Max 50% discount)

white



matte - 01M
gloss - 01G

black

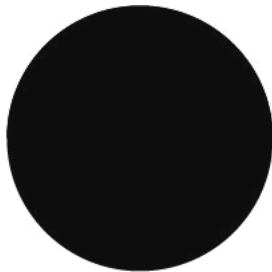

matte - 04M
gloss - 04G

efeso

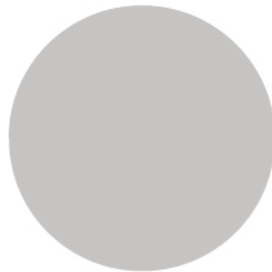

matte - 62M
gloss - 62G

bromo

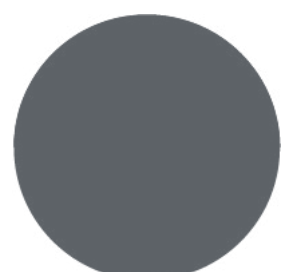

matte - 68M
gloss - 68G

ottawa

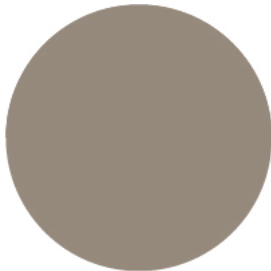

matte - 88M
gloss - 88G

londra

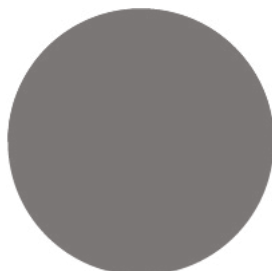

matte - 90M
gloss - 90G

jaipur

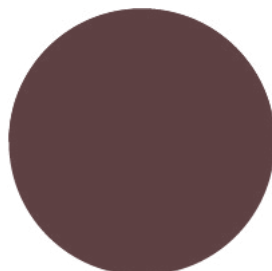

matte - 94M
gloss - 94G

orinoco

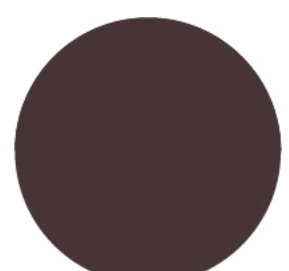

matte - 96M
gloss - 96G





45° collection series 1800 mirror F45M1-1800-01M

Mirror Frame Finishes



Black Matte lacquer · 04M



White Matte lacquer · 01M

LED Perimeter Light

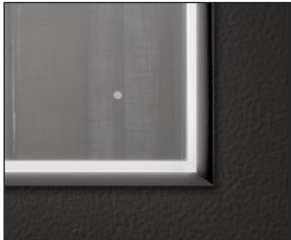
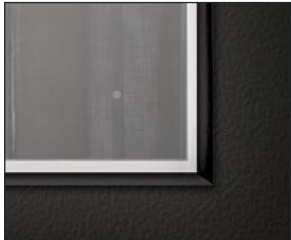

110V STRIP LED 9.6 W/MT 12V 4200°K

UL LISTED, Energy Star, IP 44

Touch Sensor Switch

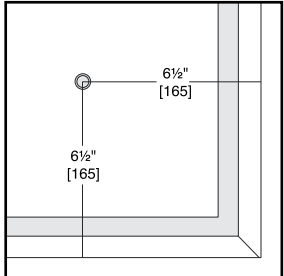

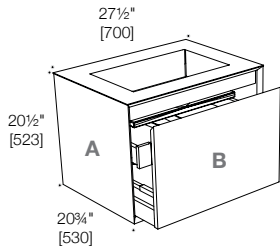

* special order finishes require 16 - 20 weeks lead time upon 50% deposit confirmation *

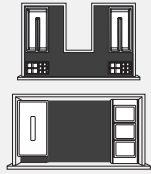

slim inner drawer + bottom drawer organization included (refer to pg 75)

(A) FXV1-0700 + (B) FXV1D-0700 or FV1D-0700.1

- 27½" W × 20½" H × 20¾" D / 700mm W x 523mm H x 530mm D
- Wall-mount vanity with integrated basin, no overflow
- Integrated basin: 19¾" W × 4¼" H × 11¾" D
- Slim drawer insert designed for plumbing clearance
- Top + lower angles feature a unique 45 degree join
- Drawer organization included: 2 storage compartments, 2 cosmetic holders, 1 storage bin set + 1 tissue box.
- Recessed integral finger pull channel with Hettich soft-close system
- Includes the drain in the same matching FENIX finish.
- Optional modern vanity towel bar AE150 available.
- Vanity frame available in a choice of White Matte (01M) or Black Matte (04M) FENIX™ finish; drawer front available in a range of wood and lacquer finishes + color

(A) vanity frame

FXV1-0700-01M* (special order)
FXV1-0700-04M* (special order)

+

(B) FENIX™ drawer front

FXV1D-0700-01M* (special order)
FXV1D-0700-04M* (special order)

or

(B) wood drawer front

FV1D-0700.1-02* (special order)
FV1D-0700.1-03* (special order)
FV1D-0700.1-04* (special order)
FV1D-0700.1-05* (special order)
FV1D-0700.1-08* (special order)
FV1D-0700.1-09* (special order)

or

(B) lacquer drawer front

FV1D-0700.1 - 01M / 04M / 62M / 68M / 88M / 90M / 94M / 96M* (special order)
FV1D-0700.1 - 01G / 04G / 62G / 68G / 88G / 90G / 94G / 96G* (special order)

How to order 45° FENIX™ vanities:

Vanity frame SKU + finish/color code
eg. FULL series 700 vanity frame in White Matte (01M)
FENIX™ finish = FXV1-0700-01M

+

Drawer front SKU + finish/color code
eg. FULL series 700 drawer front in Londra Matte (90M)
lacquer finish = FV1D-0700.1-90M

Stocked



natural oak 02

Special Order Finishes



vintage oak 03



distressed oak 04



olmo smoke 05



walnut 08



Rovere 09



white matte 01M gloss 01G



black matte 04M gloss 04G



efeso matte 62M gloss 62G



bromo matte 68M gloss 68G



ottawa matte 88M gloss 88G



londra matte 90M gloss 90G



jaipur matte 94M gloss 94G



orinoco matte 96M gloss 96G

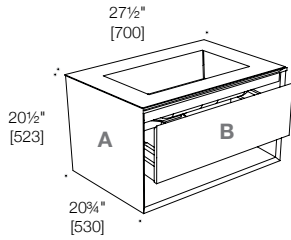

* special order finishes require 16 - 20 weeks lead time upon 50% deposit confirmation *

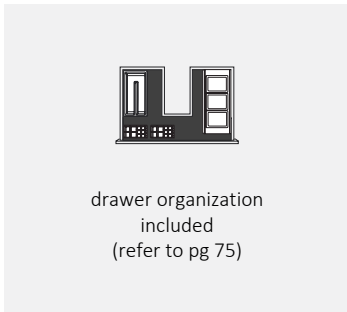

(A) FXV2-0700 + (B) FXV2D-0700 or FV2D-0700.1

- 27½" W × 20½" H × 20¾" D / 700mm W x 523mm H x 530mm D
- Wall-mount vanity with integrated basin, no overflow
- Integrated basin: 19¾" W × 4¼" H × 11¾" D / 500mm W x 110mm H x 300mm D
- Single drawer designed for plumbing clearance + open bottom shelf
- Top + lower angles feature a unique 45 degree join
- Drawer organization included: 1 storage compartment, 2 cosmetic holders + 1 storage bin set.
- Recessed integral finger pull channel with Hettich soft-close system
- Includes the drain in the same matching FENIX finish.
- Optional modern vanity towel bar AE150 available.
- Vanity frame available in a choice of White Matte (01M) or Black Matte (04M) FENIX™ finish; drawer front available in a range of wood and lacquer finishes + colors

(A) vanity frame
 FXV2-0700-01M* *(special order)*
 FXV2-0700-04M* *(special order)*

(B) + FENIX™ drawer front
 FXV2D-0700-01M* *(special order)*
 FXV2D-0700-04M* *(special order)*

or **(B) wood drawer front**
 FV2D-0700.1-02* *(special order)*
 FV2D-0700.1-03* *(special order)*
 FV2D-0700.1-04* *(special order)*
 FV2D-0700.1-05* *(special order)*
 FV2D-0700.1-08* *(special order)*
 FV2D-0700.1-09* *(special order)*

(B) lacquer drawer front
 FV2D-0700.1 - 01M / 04M / 62M / 68M / 88M / 90M / 94M / 96M* *(special order)*
 FV2D-0700.1 - 01G / 04G / 62G / 68G / 88G / 90G / 94G / 96G* *(special order)*

F45M1-0700 * Limited Stock *

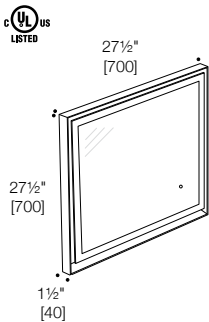

- 27½" W × 27½" H × 1½" D / 700mm W x 700mm H x 40mm D
- M1 framed mirror with soft LED perimeter lighting and touch sensor switch
- 110V strip LED 9.6 W/MT RV 4200K
- Unique 45 degree join on all four angles
- Frosted edging around mirror perimeter
- Mirror frame available in a choice of White Matte (01M) or Black Matte (04M) lacquer or Natural Oak (02) wood finish.
- LED light strip 3000K is available can be replaced onsite PT-F45M1-LED-STRIP-3
- Limited Stock

wood frame	lacquer frame
F45M1-0700-02	F45M1-0700-04M

How to order 45° mirrors:

Mirror SKU + finish/color code

eg. series 700 mirror in White Matte (01M) lacquer finish = **F45M1-0700-01M**

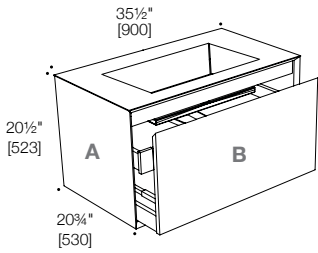

* special order finishes require 16 - 20 weeks lead time upon 50% deposit confirmation *

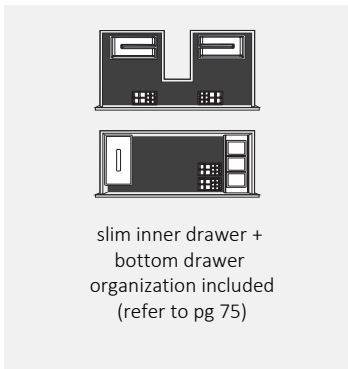

(A) FXV1-0900 + (B) FXV1D-0900 or FV1D-0900.1

- 35½" W × 20½" H × 20¾" D / 900mm W x 523mm H x 530mm D
- Wall-mount vanity with integrated basin, no overflow
- Integrated basin: 19¾" W × 4¼" H × 11¾" D / 500mm W x 110mm H x 300mm D
- Deep drawer + slim drawer insert designed for plumbing clearance
- Top + lower angles feature a unique 45 degree join
- Drawer organization included: 2 storage compartments, 4 cosmetic holders, 1 storage bin set + 1 tissue box.
- Recessed integral finger pull channel with Hettich soft-close system
- Includes the drain in the same matching FENIX finish.
- Optional modern vanity towel bar AE150 available.
- Vanity frame available in a choice of White Matte (01M) or Black Matte (04M) FENIX™ finish; drawer front available in a range of wood and lacquer finishes + colors

(A) vanity frame

FXV1-0900-01M* *(special order)*

FXV1-0900-04M* *(special order)*

+

(B) FENIX™ drawer front

FXV1D-0900-01M* *(special order)*

FXV1D-0900-04M* *(special order)*

or

(B) wood drawer front

FV1D-0900.1-02* *(in stock)*

FV1D-0900.1-03* *(special order)*

FV1D-0900.1-04* *(special order)*

FV1D-0900.1-05* *(special order)*

FV1D-0900.1-08* *(special order)*

FV1D-0900.1-09* *(special order)*

or

lacquer drawer front

(B) FV1D-0900 - 01M / 04M / 62M / 68M / 88M / 90M / 94M / 96M* *(special order)*

FV1D-0900 - 01G / 04G / 62G / 68G / 88G / 90G / 94G / 96G* *(special order)*

How to order 45° FENIX™ vanities:

Vanity frame SKU + finish/color code

eg. FULL series 900 vanity frame in Black Matte (04M)
FENIX™ finish = FXV1-0900-04M

Drawer front SKU + finish/color code

+ eg. FULL series 900 drawer front in Natural Oak (02)
wood finish = FV1D-0900.1-02

Stocked



natural oak 02

Special Order Finishes



vintage oak 03



distressed oak 04



olmo smoke 05



walnut 08



Rovere 09



white matte 01M
gloss 01G



black matte 04M
gloss 04G



efeso matte 62M
gloss 62G



bromo matte 68M
gloss 68G



ottawa matte 88M
gloss 88G



londra matte 90M
gloss 90G



jaipur matte 94M
gloss 94G



orinoco matte 96M
gloss 96G

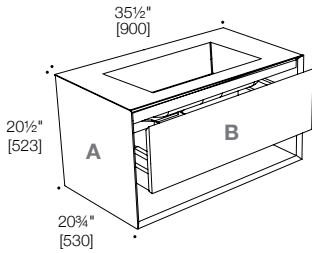

* special order finishes require
16 - 20 weeks lead time upon
50% deposit confirmation *

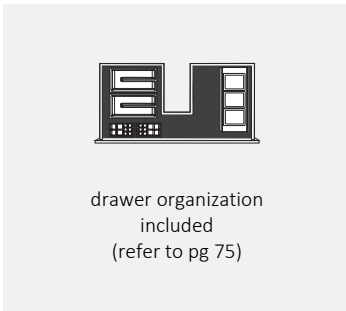

(A) FXV2-0900 + (B) FXV2D-0900 or FV2D-0900.1

- 35½" W × 20½" H × 20¾" D / 900mm W x 523mm H x 530mm D
- Wall-mount vanity with integrated basin, no overflow
- Integrated basin: 19¾" W × 4¼" H × 11¾" D / 500mm W x 110mm H x 300mm D
- Single drawer designed for plumbing clearance + open bottom shelf
- Top + lower angles feature a unique 45 degree join
- Drawer organization included: 2 storage compartments, 2 cosmetic holders + 1 storage bin set.
- Recessed integral finger pull channel with Hettich soft-close system
- Includes the drain in the same matching FENIX finish.
- Optional modern vanity towel bar AE150 available.
- Vanity frame available in a choice of White Matte (01M) or Black Matte (04M) FENIX™ finish; drawer front available in a range of wood and lacquer finishes + colors

(A) vanity frame

FXV2-0900-01M* *(special order)*
FXV2-0900-04M* *(special order)*

+

(B) FENIX™ drawer front

FXV2D-0900-01M* *(special order)*
FXV2D-0900-04M* *(special order)*

or

or **(B) wood drawer front**

FV2D-0900.1-02* *(special order)*
FV2D-0900.1-03* *(special order)*
FV2D-0900.1-04* *(special order)*
FV2D-0900.1-05* *(special order)*
FV2D-0900.1-08* *(special order)*
FV2D-0900.1-09* *(special order)*

(B) lacquer drawer front

FV2D-0900.1 - 01M / 04M / 62M / 68M / 88M / 90M / 94M / 96M* *(special order)*
FV2D-0900.1 - 01G / 04G / 62G / 68G / 88G / 90G / 94G / 96G* *(special order)*

How to order 45° mirrors:

Mirror SKU + finish/color code
eg. series 900 mirror in Black Matte (04M) lacquer finish = **F45M1-0900-04M**

(A) FXV1-1200 + (B) FXV1D-1200 or FV-1200.1

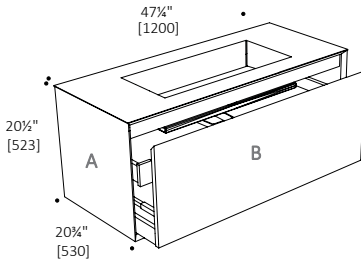

- 47¼" W × 20½" H × 20¾" D / 1200mm W x 523mm H x 530mm D
- Wall-mount vanity with integrated basin, no overflow
- Integrated basin: 27½" W × 4¼" H × 11¾" D / 700mm W x 110mm H x 300mm D
- Deep drawer + slim drawer insert designed for plumbing clearance
- Top + lower angles feature a unique 45 degree join
- Drawer organization included: 2 storage compartments, 4 cosmetic holders, 1 storage bin set + 1 tissue box.
- Recessed integral finger pull channel with Hettich soft-close system
- Includes the drain in the same matching FENIX finish.
- Optional modern vanity towel bar AE150 available.
- Vanity frame available in a choice of White Matte (01M) or Black Matte (04M) FENIX™ finish; drawer front available in a range of wood and lacquer finishes + colors

* special order finishes require 16 - 20 weeks lead time upon 50% deposit confirmation *

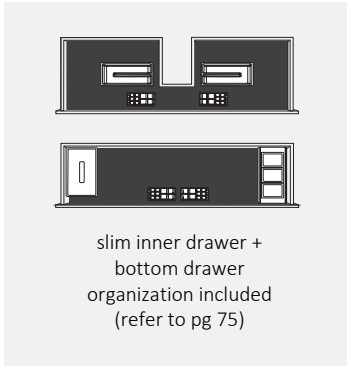

(A) vanity frame

- FXV1-1200-01M* (special order)
- FXV1-1200-04M* (special order)

+

(B) FENIX™ drawer front

- FXV1D-1200-01M* (special order)
- FXV1D-1200-04M* (special order)

or

(B) wood drawer front

- FV1D-1200.1-02* (special order)
- FV1D-1200.1-03* (special order)
- FV1D-1200.1-04* (special order)
- FV1D-1200.1-05* (special order)
- FV1D-1200.1-08* (special order)
- FV1D-1200.1-09* (special order)

or

(B) lacquer drawer front

- FV1D-1200.1 - 01M / 04M / 62M / 68M / 88M / 90M / 94M / 96M* (special order)
- FV1D-1200.1 - 01G / 04G / 62G / 68G / 88G / 90G / 94G / 96G* (special order)

How to order 45° FENIX™ vanities:

Vanity frame SKU + finish/color code
eg. UP series 1200 vanity frame in White Matte (01M)
FENIX™ finish = FXV2-1200-01M

+

Drawer front SKU + finish/color code
eg. UP series 1200 drawer front in Orinoco Matte (96M)
lacquer finish = FV2D-1200.1-96M

Stocked



natural oak 02

Special Order Finishes



vintage oak 03



distressed oak 04



olmo smoke 05



walnut 08



Rovere 09



white matte 01M
gloss 01G



black matte 04M
gloss 04G



efeso matte 62M
gloss 62G



bromo matte 68M
gloss 68G



ottawa matte 88M
gloss 88G



londra matte 90M
gloss 90G



jaipur matte 94M
gloss 94G



orinoco matte 96M
gloss 96G

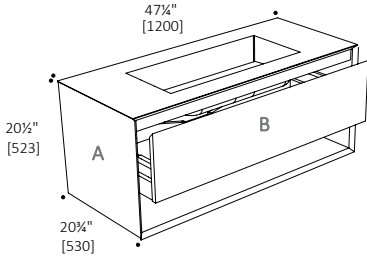

* special order finishes require 16 - 20 weeks lead time upon 50% deposit confirmation *

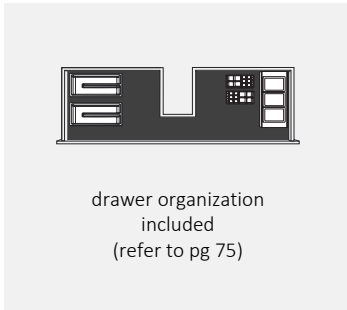

(A) FXV2-1200 + (B) FXV2D-1200 or FV-1200.1

- 47 1/4" W x 20 1/2" H x 20 3/4" D / 1200mm W x 523mm H x 530mm D
- Wall-mount vanity with integrated basin, no overflow
- Integrated basin: 27 1/2" W x 4 1/4" H x 11 3/4" D / 700mm W x 110mm H x 300mm D
- Single drawer designed for plumbing clearance + open bottom shelf
- Top + lower angles feature a unique 45 degree join
- Drawer organization included: 2 storage compartments, 2 cosmetic holders + 1 storage bin set (refer to pg 76 B)
- Recessed integral finger pull channel with Hettich soft-close system
- Includes the drain in the same matching FENIX finish.
- Optional modern vanity towel bar AE150 available.
- Vanity frame available in a choice of White Matte (01M) or Black Matte (04M) FENIX™ finish; drawer front available in a range of wood and lacquer finishes + colors

(A) vanity frame

FXV2-1200-01M* (special order)

FXV2-1200-04M* (special order)

+

(B) FENIX™ drawer front

FXV2D-1200-01M* (special order)

FXV2D-1200-04M* (special order)

or

or **(B) wood drawer front**

FV2D-1200.1-02* (special order)

FV2D-1200.1-03* (special order)

FV2D-1200.1-04* (special order)

FV2D-1200.1-05* (special order)

FV2D-1200.1-08* (special order)

FV2D-1200.1-09* (special order)

(B) lacquer drawer front

FV2D-1200.1 - 01M / 04M / 62M / 68M / 88M / 90M / 94M / 96M* (special order)

FV2D-1200.1 - 01G / 04G / 62G / 68G / 88G / 90G / 94G / 96G* (special order)

F45M1-1200 * Limited Stock *

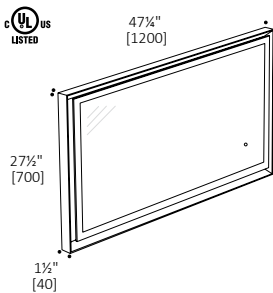

- 47 1/4" W x 27 1/2" H x 1 1/2" D / 1200mm W x 700mm H x 40mm D
 - Framed mirror with soft LED perimeter lighting and touch sensor switch
 - 110V strip LED 9.6 W/MT RV 4200K
 - Unique 45 degree join on all four angles
 - Frosted edging around mirror perimeter
 - Mirror frame available in a choice of White Matte (01M) or Black Matte (04M) lacquer or Natural Oak (02) wood finish (refer to pgs 14-17 B) LED
 - light strip 3000K is available can be replaced onsite
- PT-F45M1-LED-STRIP-4

wood frame

lacquer frame

F45M1-1200-02

F45M1-1200-04M*

How to order 45° mirrors:

Mirror SKU + finish/color code

eg. series 1200 mirror in White Matte (01M) lacquer finish = **F45M1-1200-01M**

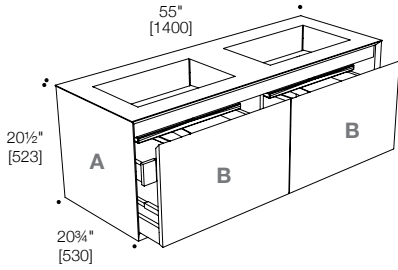

* special order finishes require 16 - 20 weeks lead time upon 50% deposit confirmation *

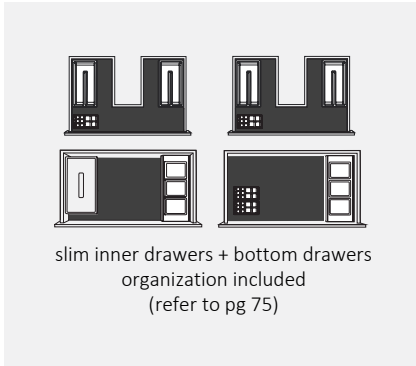

(A) FXV1-1400 + (B) FXV1D-1400 or FV1D-1400.1

- 55" W x 20½" H x 20¾" D / 1400mm W x 523mm H x 530mm D
- Wall-mount double vanity with integrated basins, no overflow
- Integrated basins: 27½" W x 4¼" H x 11¾" D / 700mm W x 110mm H x 300mm D
- Two deep drawers + slim drawer inserts designed for plumbing clearance
- Top + lower angles feature a unique 45 degree join
- Drawer organization included: 4 storage compartments, 4 cosmetic holders, 2 storage bin sets + 1 tissue box.
- Recessed integral finger pull channel with Hettich soft-close system
- Includes the drain in the same matching FENIX finish.
- Optional modern vanity towel bar AE150 available.
- Vanity frame available in a choice of White Matte (01M) or Black Matte (04M) FENIX™ finish; drawer front available in a range of wood and lacquer finishes + colors

(A) double vanity frame

FXV1-1400-01M* *(special order)*
 FXV1-1400-04M* *(special order)*

+

(B) FENIX™ drawer front x2

FXV1D-1400-01M* *(special order)*
 FXV1D-1400-04M* *(special order)*

or

(B) wood drawer front x2

FV1D-1400.1-02* *(special order)*
 FV1D-1400.1-03* *(special order)*
 FV1D-1400.1-04* *(special order)*
 FV1D-1400.1-05* *(special order)*
 FV1D-1400.1-08* *(special order)*
 FV1D-1400.1-09* *(special order)*

or

(B) lacquer drawer front x2

FV1D-1400.1 - 01M / 04M / 62M / 68M / 88M / 90M / 94M / 96M* *(special order)*
 FV1D-1400.1 - 01G / 04G / 62G / 68G / 88G / 90G / 94G / 96G* *(special order)*

How to order 45° FENIX™ vanities:

Vanity frame SKU + finish/color code
 eg. FULL series 1400 vanity frame in Black Matte (04M)
 FENIX™ finish = FXV1-1400-04M

+

Drawer front SKU + finish/color code
 eg. FULL series 1400 drawer front in Black Gloss (04G)
 lacquer finish = FV1D-1400.1-04G

Stocked



natural oak
02

Special Order Finishes



vintage oak
03



distressed oak
04



olmo smoke
05



walnut
08



Rovere
09



white matte 01M
gloss 01G



black matte 04M
gloss 04G



efeso matte 62M
gloss 62G



bromo matte 68M
gloss 68G



ottawa matte 88M
gloss 88G



londra matte 90M
gloss 90G



jaipur matte 94M
gloss 94G



orinoco matte 96M
gloss 96G

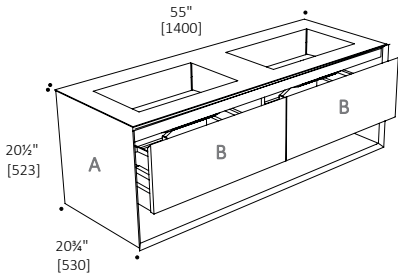

* special order finishes require
16 - 20 weeks lead time upon
50% deposit confirmation *

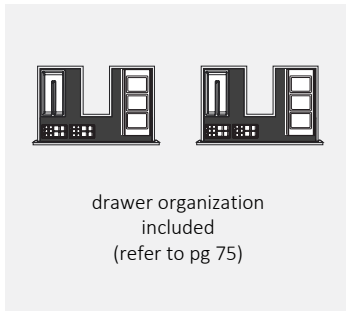

(A) FXV2-1400 + (B) FXV2D-1400 or FV2D-1400.1

- 55" W x 20½" H x 20¾" D / 1400mm W x 523mm H x 530mm D
- Wall-mount double vanity with integrated basins, no overflow
- Integrated basins: 27½" W x 4¼" H x 11¾" D / 700mm W x 110mm H x 300mm D
- Two deep drawers designed for plumbing clearance + open bottom shelf
- Top + lower angles feature a unique 45 degree join
- Drawer organization included: 2 storage compartments, 4 cosmetic holders + 2 storage bin sets.
- Includes the drain in the same matching FENIX finish.
- Optional modern vanity towel bar AE150 available.
- Vanity frame available in a choice of White Matte (01M) or Black Matte (04M) FENIX™ finish; drawer front available in a range of wood and lacquer finishes + colors

(A) double vanity frame

FXV2-1400-01M* (special order)

FXV2-1400-04M* (special order)

+

(B) FENIX™ drawer front x2

FXV2D-1400-01M* (special order)

FXV2D-1400-04M* (special order)

OR

lacquer drawer front x2

OR **(B) wood drawer front x2**

FV2D-1400.1-02* (special order)

FV2D-1400.1-03* (special order)

FV2D-1400.1-04* (special order)

FV2D-1400.1-05* (special order)

FV2D-1400.1-08* (special order)

FV2D-1400.1-09* (special order)

(B)

FV2D-1400.1 - 01M / 04M / 62M / 68M / 88M / 90M / 94M / 96M* (special order)

FV2D-1400.1 - 01G / 04G / 62G / 68G / 88G / 90G / 94G / 96G* (special order)

F45M1-1400

* Limited Stock *

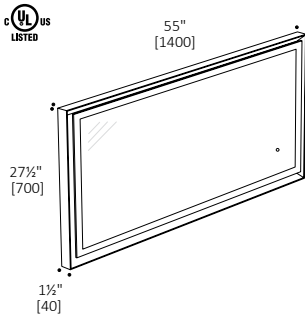

- 55" W x 27½" H x 1½" D / 1400mm W x 700mm H x 40mm D Framed mirror with soft LED perimeter lighting and touch sensor switch
- 110V strip LED 9.6 W/MT RV 4200K
- Unique 45 degree join on all four angles
- Frosted edging around mirror perimeter
- Mirror frame available in a choice of White Matte (01M) or Black Matte (04M) lacquer or Natural Oak (02) wood finish (refer to pgs 14-17 B) LED
- light strip 3000K is available can be replaced onsite

PT-F45M1-LED-STRIP-4

lacquer frame

F45M1-1400-01M

F45M1-1400-04M*

How to order 45° mirrors:

Mirror SKU + finish/color code

eg. series 1400 mirror in Black Matte (04M) lacquer finish = **F45M1-1400-04M**

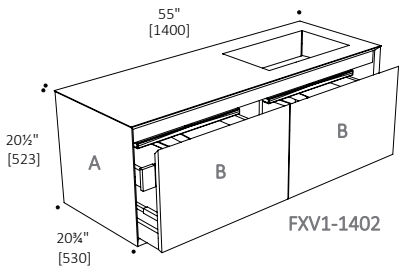
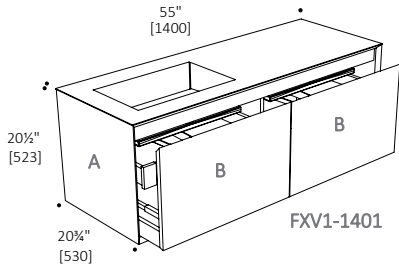

* special order finishes require
16 - 20 weeks lead time upon
50% deposit confirmation *

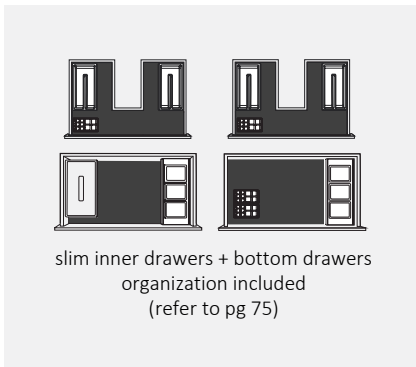

(A) FXV1-1401 or FXV1D-1402 + (B) FXV1D-1400 or FV1D-1400.1

- 55" W x 20½" H x 20¾" D / 1400mm W x 523mm H x 530mm D
- Wall-mount double vanity with left-hand or right-hand integrated basin, no overflow
- Integrated basin: 27½" W x 4¼" H x 11¾" D / 700mm W x 110mm H x 300mm D
- Two deep drawers + slim drawer inserts designed for plumbing clearance
- Top + lower angles feature a unique 45 degree join
- Drawer organization included: 4 storage compartments, 4 cosmetic holders, 2 storage bin sets + 1 tissue box.
- Recessed integral finger pull channel with Hettich soft-close system
- Includes the drain in the same matching FENIX finish.
- Optional modern vanity towel bar AE150 available.
- Vanity frame available in a choice of White Matte (01M) or Black Matte (04M) FENIX™ finish; drawer front available in a range of wood and lacquer finishes + colors

(A) left basin frame

FXV1-1401-01M* (special order)
FXV1-1401-04M* (special order)

right basin frame

or FXV1-1402-01M* (special order)
FXV1-1402-04M* (special order)

+

(B) FENIX™ drawer front x2

FXV1D-1400-01M* (special order)
FXV1D-1400-04M* (special order)

or

(B) wood drawer front x2

FV1D-1400.1-02* (special order)
FV1D-1400.1-03* (special order)
FV1D-1400.1-04* (special order)
FV1D-1400.1-05* (special order)
FV1D-1400.1-08* (special order)
FV1D-1400.1-09* (special order)

or

(B) lacquer drawer front x2

FV1D-1400.1 - 01M / 04M / 62M / 68M / 88M / 90M / 94M / 96M* (special order)
FV1D-1400.1 - 01G / 04G / 62G / 68G / 88G / 90G / 94G / 96G* (special order)

How to order 45° FENIX™ vanities:

Vanity frame SKU + finish/color code
eg. FULL series 1400 vanity frame in Black Matte (04M)
FENIX™ finish = **FXV1-1401-04M**

+

Drawer front SKU + finish/color code
eg. FULL series 1400 drawer front in Natural Oak (02)
wood finish = **FV1D-1400.1-02**

Stocked



natural oak 02

Special Order Finishes



vintage oak 03



distressed oak 04



olmo smoke 05



walnut 08



Rovere 09



white matte 01M
gloss 01G



black matte 04M
gloss 04G



efeso matte 62M
gloss 62G



bromo matte 68M
gloss 68G



ottawa matte 88M
gloss 88G



londra matte 90M
gloss 90G



jaipur matte 94M
gloss 94G



orinoco matte 96M
gloss 96G

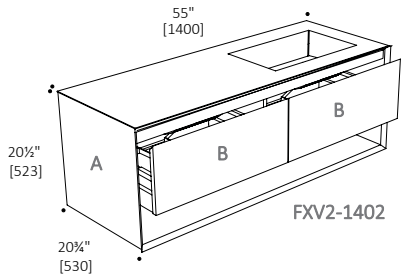
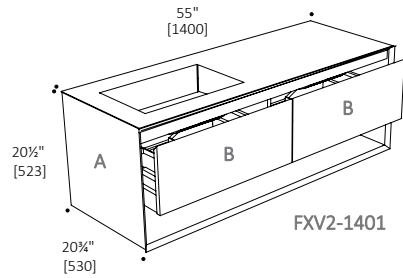

* special order finishes require 16 - 20 weeks lead time upon 50% deposit confirmation *

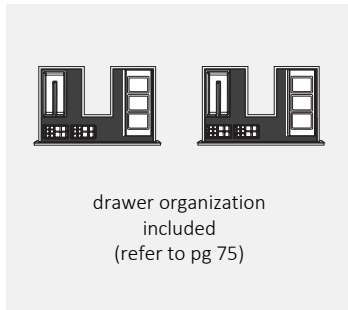

(A) FXV2-1401 or FXV2-1402 + (B) FXV2D-1400 or FV2D-1400.1

- 55" W x 20½" H x 20¾" D / 1400mm W x 523mm H x 530mm D
- Wall-mount double vanity with left-hand or right-hand integrated basin, no overflow
- Integrated basin: 27½" W x 4¼" H x 11¾" D / 700mm W x 110mm H x 300mm D
- Two deep drawers + slim drawer inserts designed for plumbing clearance
- Top + lower angles feature a unique 45 degree join
- Drawer organization included: 2 storage compartments, 4 cosmetic holders + 2 storage bin sets.
- Recessed integral finger pull channel with Hettich soft-close system
- Includes the drain in the same matching FENIX finish.
- Optional modern vanity towel bar AE150 available.
- Vanity frame available in a choice of White Matte (01M) or Black Matte (04M) FENIX™ finish; drawer front available in a range of wood and lacquer finishes + colors

(A) left basin frame

FXV2-1401-01M* (special order)
FXV2-1401-04M* (special order)

OR

right basin frame

FXV2-1402-01M* (special order)
FXV2-1402-04M* (special order)

+

(B) FENIX™ drawer front x2

FXV2D-1400-01M* (special order)
FXV2D-1400-04M* (special order)

OR

(B) wood drawer front x2

FV2D-1400.1-02* (special order)
FV2D-1400.1-03* (special order)
FV2D-1400.1-04* (special order)
FV2D-1400.1-05* (special order)
FV2D-1400.1-08* (special order)
FV2D-1400.1-09* (special order)

OR

(B) lacquer drawer front x2

FV2D-1400.1 - 01M / 04M / 62M / 68M / 88M / 90M / 94M / 96M* (special order)
FV2D-1400.1 - 01G / 04G / 62G / 68G / 88G / 90G / 94G / 96G* (special order)

45° FENIX™ furniture

How to order 45° FENIX™ vanities:

Vanity frame SKU + finish/color code
eg. UP series 1400 vanity frame in White Matte (01M)
FENIX™ finish = **FXV2-1402-01M**

+

Drawer front SKU + finish/color code
eg. UP series 1400 drawer front in White Matte (01M)
lacquer finish = **FV2D-1400.1-01M**

Stocked



natural oak 02

Special Order Finishes



vintage oak 03



distressed oak 04



olmo smoke 05



walnut 08



Rovere 09



white matte 01M
gloss 01G



black matte 04M
gloss 04G



efeso matte 62M
gloss 62G



bromo matte 68M
gloss 68G



ottawa matte 88M
gloss 88G



londra matte 90M
gloss 90G



jaipur matte 94M
gloss 94G



orinoco matte 96M
gloss 96G

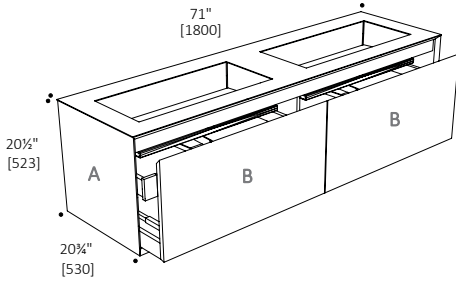

* special order finishes require 16 - 20 weeks lead time upon 50% deposit confirmation *

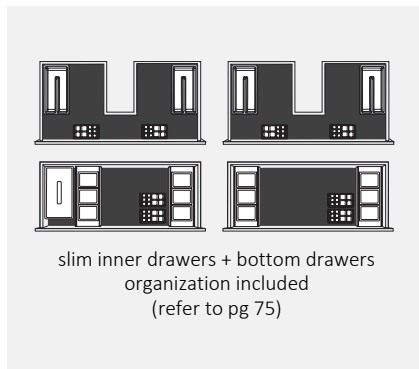

(A) FXV1-1800 + (B) FXV1D-1800or FV1D-1800.1

- 71" W x 20½" H x 20¾" D / 1800mm W x 523mm H x 530mm D
- Wall-mount double vanity with integrated basins, no overflow
- Integrated basins: 27½" W x 4¼" H x 11¾" D / 700mm W x 110mm H x 300mm D
- Two deep drawers + slim drawer inserts designed for plumbing clearance
- Top + lower angles feature a unique 45 degree join
- Drawer organization included: 4 storage compartments, 8 cosmetic holders, 4 storage bin sets + 1 tissue box.
- Recessed integral finger pull channel with Hettich soft-close system
- Includes the drain in the same matching FENIX finish
- Optional modern vanity towel bar AE150 available
- Vanity frame available in a choice of White Matte (01M) or Black Matte (04M) FENIX™ finish; drawer front available in a range of wood and lacquer finishes + colors

(A) double vanity frame

- FXV1-1800-01M* (special order)
- FXV1-1800-04M* (special order)

+

(B) FENIX™ drawer front x2

- FXV1D-1800-01M* (special order)
- FXV1D-1800-04M* (special order)

or

(B) wood drawer front x2

- FV1D-1800.1-02* (special order)
- FV1D-1800.1-03* (special order)
- FV1D-1800.1-04* (special order)
- FV1D-1800.1-05* (special order)
- FV1D-1800.1-08* (special order)
- FV1D-1800.1-09* (special order)

or

(B) lacquer drawer front x2

- FV1D-1800.1 - 01M / 04M / 62M / 68M / 88M / 90M / 94M / 96M* (special order)
- FV1D-1800.1 - 01G / 04G / 62G / 68G / 88G / 90G / 94G / 96G* (special order)

How to order 45° FENIX™ vanities:

Vanity frame SKU + finish/color code
eg. FULL series 1800 vanity frame in White Matte (01M)
FENIX™ finish = FXV1-1800-01M

+

Drawer front SKU + finish/color code
eg. FULL series 1800 drawer front in Ottawa Gloss (88G)
lacquer finish = FV1D-1800.1-88G

Stocked



natural oak 02

Special Order Finishes



vintage oak 03



distressed oak 04



olmo smoke 05



walnut 08



Rovere 09



white matte 01M
gloss 01G



black matte 04M
gloss 04G



efeso matte 62M
gloss 62G



bromo matte 68M
gloss 68G



ottawa matte 88M
gloss 88G



londra matte 90M
gloss 90G



jaipur matte 94M
gloss 94G



orinoco matte 96M
gloss 96G

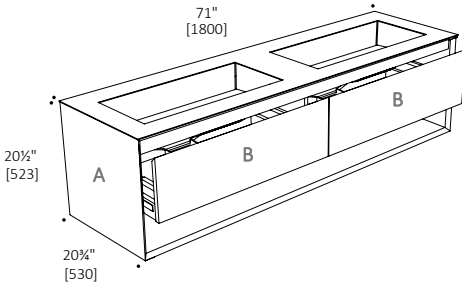

(A) FXV2-1800 + (B) FXV2D-1800 or FV2D-1800.1

- 71" W x 20½" H x 20¾" D / 1800mm W x 523mm H x 530mm D
- Wall-mount double vanity with integrated basins, no overflow
- Integrated basins: 27½" W x 4¼" H x 11¼" D / 700mm W x 110mm H x 300mm
- Two deep drawers designed for plumbing clearance + open bottom shelf
- Top + lower angles feature a unique 45 degree join
- Drawer organization included: 4 storage compartments, 4 cosmetic holders + 4 storage bin sets.
- Recessed integral finger pull channel with Hettich soft-close system
- Includes the drain in the same matching FENIX finish.
- Optional modern vanity towel bar AE150 available.
- Vanity frame available in a choice of White Matte (01M) or Black Matte (04M) FENIX™ finish; drawer front available in a range of wood and lacquer finishes + colors

* special order finishes require 16 - 20 weeks lead time upon 50% deposit confirmation *

(A) double vanity frame

- FXV2-1800-01M* *(special order)*
- FXV2-1800-04M* *(special order)*

+

(B) FENIX™ drawer front x2

- FXV2D-1800-01M* *(special order)*
- FXV2D-1800-04M* *(special order)*

or

or **(B) wood drawer front x2**

- FV2D-1800.1-02* *(special order)*
- FV2D-1800.1-03* *(special order)*
- FV2D-1800.1-04* *(special order)*
- FV2D-1800.1-05* *(special order)*
- FV2D-1800.1-08* *(special order)*
- FV2D-1800.1-09* *(special order)*

(B) lacquer drawer front x2

- FV2D-1800.1 - 01M / 04M / 62M / 68M / 88M / 90M / 94M / 96M* *(special order)*
- FV2D-1800.1 - 01G / 04G / 62G / 68G / 88G / 90G / 94G / 96G* *(special order)*

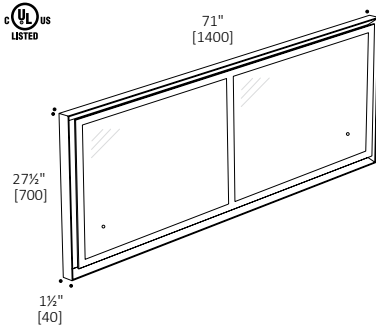
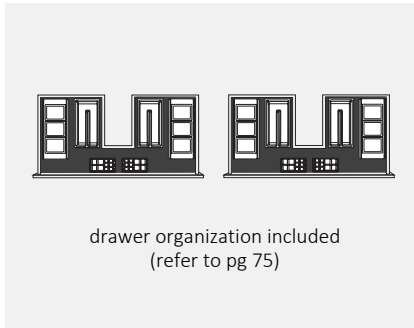

F45M1-1800 * Limited Stock *

- 71" W x 27½" H x 1½" D / 1800mm W x 700mm H x 40mm D
- Framed double mirror with soft LED perimeter lighting and two touch sensor switches
- 110V strip LED 9.6 W/MT RV 4200K
- Unique 45 degree join on all four angles
- Frosted edging around mirror perimeter and vertically through center
- Mirror frame available in a choice of White Matte (01M) or Black Matte (04M) lacquer or Natural Oak (02) wood finish.
- LED light strip 3000K is available can be replaced onsite
- 2x PT-F45M1-LED-STRIP-3

• **wood frame**

F45M1-1800-02

• **lacquer frame**

F45M1-1800-01M

How to order 45° mirrors:

Mirror SKU + finish/color code

eg. series 1800 mirror in White Matte (01M) lacquer finish = **F45M1-1800-01M**

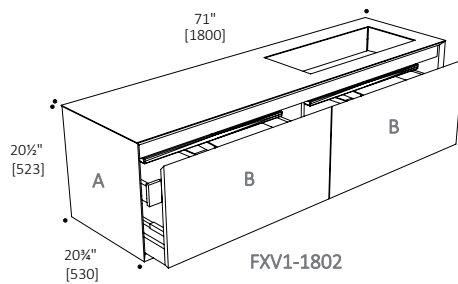
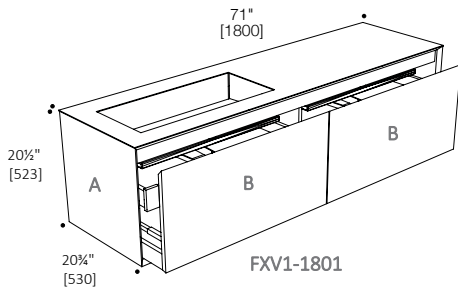

* special order finishes require 16 - 20 weeks lead time upon 50% deposit confirmation *

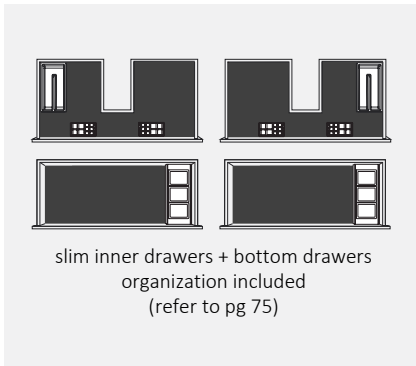

(A) FXV1-1801 or FXV1-18002 + (B) FXV2D-1800 or FV2D-1800.1

- 71" W x 20½" H x 20¾" D / 1800mm W x 523mm H x 530mm D
- Wall-mount double vanity with left-hand or right-hand integrated basin, no overflow
- Integrated basin: 27½" W x 4¼" H x 11¾" D / 700mm W x 110mm H x 300mm D
- Two deep drawers + slim drawer inserts designed for plumbing clearance
- Top + lower angles feature a unique 45 degree join
- Drawer organization included: 4 storage compartments, 8 cosmetic holders, 4 storage bin sets + 1 tissue box.
- Recessed integral finger pull channel with Hettich soft-close system
- Includes the drain in the same matching FENIX finish.
- Optional modern vanity towel bar AE150 available.
- Vanity frame with sloped basin cover available in a choice of White Matte (01M) or Black Matte (04M) FENIX™ finish; drawer fronts available in a range of wood and lacquer finishes + colors

(A) left basin frame

- FXV1-1801-01M* (special order)
- FXV1-1801-04M* (special order)

right basin frame

- or
- FXV1-1802-01M* (special order)
 - FXV1-1802-04M* (special order)

FENIX™ drawer front x2

- (B) FXV1D-1800-01M* (special order)**
FXV1D-1800-04M* (special order)

or

(B) wood drawer front x2

- FV1D-1800.1-02* (special order)
- FV1D-1800.1-03* (special order)
- FV1D-1800.1-04* (special order)
- FV1D-1800.1-05* (special order)
- FV1D-1800.1-08* (special order)
- FV1D-1800.1-09* (special order)

or

(B) lacquer drawer front x2

- FV1D-1800.1 - 01M / 04M / 62M / 68M / 88M / 90M / 94M / 96M* (special order)
- FV1D-1800.1 - 01G / 04G / 62G / 68G / 88G / 90G / 94G / 96G* (special order)

How to order 45° FENIX™ vanities:

Vanity frame SKU + finish/color code
 eg. FULL series 1800 vanity frame in White Matte (01M)
 FENIX™ finish = FXV1-1801-01M

+

Drawer front SKU + finish/color code
 eg. FULL series 1800 drawer front in Vintage Oak (03)
 wood finish = FV1D-1800.1-03

Stocked



natural oak 02

Special Order Finishes



vintage oak 03



distressed oak 04



olmo smoke 05



walnut 08



Rovere 09



white matte 01M
gloss 01G



black matte 04M
gloss 04G



efeso matte 62M
gloss 62G



bromo matte 68M
gloss 68G



ottawa matte 88M
gloss 88G



londra matte 90M
gloss 90G



jaipur matte 94M
gloss 94G



orinoco matte 96M
gloss 96G

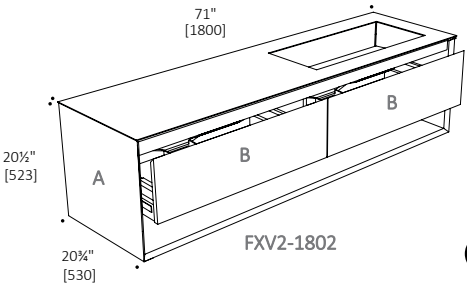
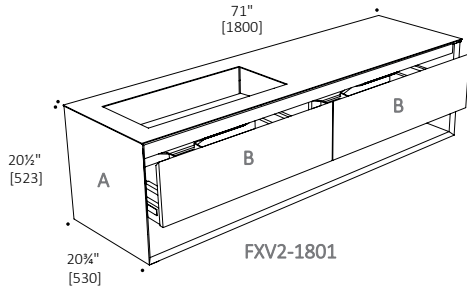

* special order finishes require
16 - 20 weeks lead time upon
50% deposit confirmation *

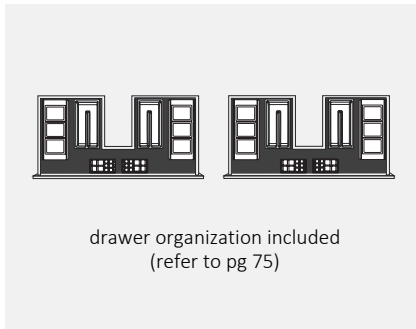

(A) FXV2-1801 or FXV2-18002 + (B) FXV2D-1800 or FV2D-1800.1

- 71" W x 20½" H x 20¾" D / 1800mm W x 523mm H x 530mm D
- Wall-mount double vanity with left-hand or right-hand integrated basin, no overflow
- Integrated basin: 27½" W x 4¼" H x 11¼" D / 700mm W x 110mm H x 300mm.
- Two deep drawers designed for plumbing clearance + open bottom shelf
- Top + lower angles feature a unique 45 degree join
- Drawer organization included: 4 storage compartments, 4 cosmetic holders + 4 storage bin sets.
- Recessed integral finger pull channel with Hettich soft-close system
- Includes the drain in the same matching FENIX finish.
- Optional modern vanity towel bar AE150 available.
- Vanity frame with sloped basin cover available in a choice of White Matte (01M) or Black Matte (04M) FENIX™ finish; drawer fronts available in a range of wood and lacquer finishes + colors

(A) left basin frame

FXV2-1801-01M* (special order)
FXV2-1801-04M* (special order)

right basin frame

FXV2-1802-01M* (special order)
FXV2-1802-04M* (special order)

OR

+

(B) FENIX™ drawer front x2

FXV2D-1800-01M* (special order)
FXV2D-1800-04M* (special order)

OR **(B) wood drawer front x2**

FV2D-1800.1-02* (special order)
FV2D-1800.1-03* (special order)
FV2D-1800.1-04* (special order)
FV2D-1800.1-05* (special order)
FV2D-1800.1-08* (special order)
FV2D-1800.1-09* (special order)

OR

(B) lacquer drawer front x2

FV2D-1800.1 - 01M / 04M / 62M / 68M / 88M / 90M / 94M / 96M* (special order)
FV2D-1800.1 - 01G / 04G / 62G / 68G / 88G / 90G / 94G / 96G* (special order)

How to order 45° FENIX™ vanities:

Vanity frame SKU + finish/color code
eg. UP series 1800 vanity frame in White Matte (01M)
FENIX™ finish = **FXV2-1802-01M**

+

Vanity frame SKU + finish/color code
eg. UP series 1800 vanity frame in White Matte (01M)
FENIX™ finish = **FXV2-1802.1-01M**

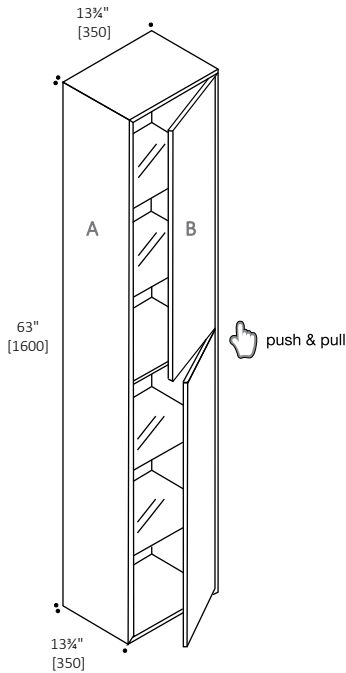

* special order finishes require 16 - 20 weeks lead time upon 50% deposit confirmation *

(A) FXV1-1600+ (B) FW1D-1600

- 13 3/4" W x 63" H x 13 3/4" D / 350mm W x 1600mm H x 350mm
- Wall-mount bathroom cabinet with shelving + individual top & bottom doors
- Frame is designed for left or right-hand door installation
- Shelving includes: 4 glass + 1 wood
- Push/pull opening system
- Unique 45 degree join on all four angles
- Cabinet frame available in a choice of White Matte (01M) or Black Matte (04M) FENIX™ finish; door fronts available in a range of wood and lacquer finishes + colors

(A) cabinet frame

- FXW1-1600-01M* *(special order)*
- FXW1-1600-04M* *(special order)*

+

(B) FENIX™ door fronts

- FXW1D-1600-01M* *(special order)*
- FXW1D-1600-04M* *(special order)*

OR

(B) wood door fronts

- FW1D-1600-02* *(special order)*
- FW1D-1600-03* *(special order)*
- FW1D-1600-04* *(special order)*
- FW1D-1600-05* *(special order)*
- FW1D-1600-08* *(special order)*
- FW1D-1600-09* *(special order)*

OR

(B) lacquer door fronts

- FW1D-1600 - 01M / 04M / 62M / 68M / 88M / 90M / 94M / 96M* *(special order)*
- FW1D-1600 - 01G / 04G / 62G / 68G / 88G / 90G / 94G / 96G* *(special order)*

How to order a 45° FENIX™ wall cabinet:

Cabinet frame SKU + finish/color code eg. cabinet frame in black matte (04M) FENIX™ finish = FXW1-1600-04M

+

Door front SKU + finish/color code eg. door front in Distressed Oak (04) wood finish = FW1D-1600-04

Stocked



natural oak 02

Special Order Finishes



vintage oak 03



distressed oak 04



olmo smoke 05



walnut 08



Rovere 09



white matte 01M gloss 01G



black matte 04M gloss 04G



efeso matte 62M gloss 62G



bromo matte 68M gloss 68G



ottawa matte 88M gloss 88G



londra matte 90M gloss 90G



jaipur matte 94M gloss 94G



orinoco matte 96M gloss 96G



SC015

- Universal push button waste,
- Suitable for both overflow and no overflow applications
- Shrouded threads + tailpiece included with waste
- Stainless steel AISI316L

finish

- AS
- ON*
- OC*

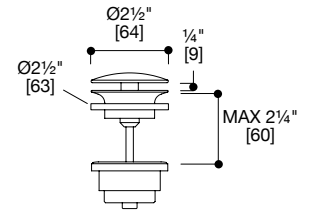

*Finishes: ON, OC are Special Order items and require a 6-8 week lead time upon order confirmation

QTW-0120

- Push button waste without overflow
- Shrouded threads + tailpiece included with waste
- Stainless steel AISI316L
- Designed for use with blu-stone™ waste cover

finish

- AS

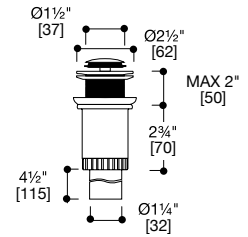

QTW-0121

- Push button waste with overflow
- Shrouded threads + tailpiece included with waste
- Stainless steel AISI316L
- Designed for use with blu-stone™ waste cover

finish

- AS

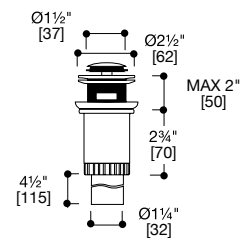



F01AC-01

- Kit includes 2 storage compartments, suitable for all 45°, 45° FENIX™ and 51 vanities
- Individual Storage Compartment:
10½" L x 5½" W x 1¾" H / 269mm L x 139mm W x 42mm H
- Ideal for organizing make-up brushes and other beauty accessories



F01AC-02

- Kit includes 2 cosmetic holders, suitable for all 45°, 45° FENIX™ and 51 vanities
- Individual Cosmetic Holder:
5½" L x 2¾" W x 1½" H / 139mm L x 73mm W x 41mm H
- Ideal for organizing nail polishes, lipsticks, beauty pencils and other small items



F01AC-03

- Kit includes 2 storage bin sets, suitable for all 45°, 45° FENIX™ and 51 vanities
- Individual Storage Bin:
13¾" L x 5¾" W x 2¾" H / 334mm L x 146mm W x 41mm H
- Ideal for storing jewelry, cotton balls and other essentials



F01AC-04

- Kit includes 1 tissue box, suitable for all 45°, 45° FENIX™ and 51 vanities
- Tissue Box:
11¼" L x 6¼" W x 3½" H / 286mm L x 156mm W x 90mm H

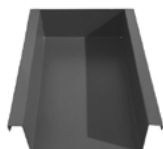

F45AC-01

- Drawer filler designed to slot into the slim inner drawer of series 1400 + 1800 45° and 45° FENIX™ collection vanites
- Provides additional storage space when plumbing clearance is not required
- Drawer filler:
7¼" W x 2¼" H x 10" D / 182mm W x 59mm H x 251mm D

51

furniture collection

vanities
mirrors



51 collection series 1200 vanity F51V1-1200-01M



51 collection series 1200 vanity F51V1-1200-K31



51 collection series 1200 vanity F51V1-1200-K33

features + benefits

Blu Bathworks 51 furniture collection is a modular line of Italian-crafted vanities available in the innovative Hard Surface Technology (HST) range of finishes. This collection features six series, ranging from in width from 23½" to 71" with coordinating blu-stone™ vanity top basins and choice of mirrors with LED lighting.



Innovative Hard Surface Technology (HST) Finishes

The line of 51 vanities are designed with a choice of Hard Surface Technology (HST) finishes, which offer extraordinary technical performance in terms of exceptional durability, extremely high resistance to scratches and chemicals, all in addition to a beautiful aesthetic and tactile wood grain effect.



Plumbing Clearance Drawer Design

The slim drawer within a drawer design of 51 vanities provides quick & easy access to smaller items, while facilitating a clean, minimalist look externally. Vanity drawers are designed to maximize storage space while separating stored items from plumbing drain pipes.



Push/Pull + Soft-Close Operation

Invoking a minimalist, handle-free aesthetic, 51 vanities feature an easy push/pull opening system – ensuring convenient opening with a gentle push anywhere along the drawer front, providing a smooth, soft-close operation every time.

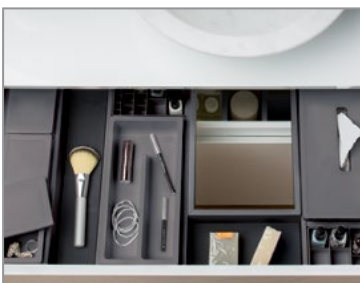

Optional Vanity Drawer Organization Kits

To facilitate bathroom organization and storage, a selection of optional drawer organization kits are available for all 51 vanities, including small storage compartments (F01AC-01), cosmetic holders (F01AC-02), storage bin sets (F01AC-03) and tissue box (F01AC-04) – all designed to provide storage and easy access to smaller items at your fingertips!

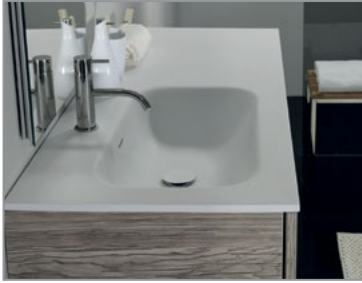

Coordinating blu-stone™ Vanity Tops

Vanity tops are available in Blu Bathworks signature eco-friendly blu-stone™ material – crafted primarily from quartzite – in a range of widths from 23¾" to 71" to coordinate with each 51 vanity. All blu-stone™ vanity tops are available in ½" thickness with choice of matte or gloss finish; series 1200 & 1400 are also available in 1-4" thickness.



Mirror Design Options

51 collection offers multiple mirror design options: M1 features vertical LED lighting and a box perimeter frame in White Matte lacquer finish – which doubles as a stylish shelf for toiletries! M2 is a thin profile frameless mirror design with LED perimeter lighting.



LED Lighting

Both M1 and M2 mirror designs incorporate soft LED lighting with color temperature 4200K. M1 box mirror features two vertical LED strip lights operated by a discreet infrared switch located under the shelf. While the M2 frameless mirror features an LED perimeter lights, subtly positioned behind the mirror, operated by a discreet touch sensor switch located on the mirror face.

Quick & Easy Installation

Great care has been taken in the design of 51 vanities and mirrors to ensure convenient installation, including an integral channel on the backside of each mirror to allow the installer to adjust brackets to hit studs accordingly.

Similarly, all 51 vanities are equipped with one continuous bracket along the backside to allow easy retro-fitting / hitting studs where backing or additional support is not available.

finish + color guide

51 FULL VANITY

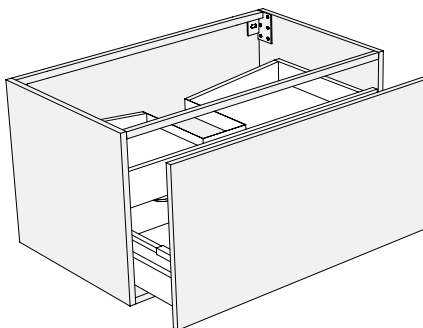

DESIGN OPTION: V1

Materials:

vanity frame & drawer front

Hard Surface Technology (HST)

Melamine panel IDROLEB, W100
(water-repellent) and scratch resistant

Lacquer

Engineered wood (MDF) panel IDROLEB

How to quote your 51 vanity order:

Vanity SKU + furniture finish/color code

eg. FULL series 900 vanity in salinas (K31) HST finish = **F51V1-0900-K31**

LACQUER + HST

Please refer to furniture sample chips for true finish and color.

51 vanity

stocked

white matte



01M

special order*
(max 50% discount)

white gloss



01G*

salinas



K31*

charlestone



K33*

*Special Order finishes require a 16-20 weeks leadtime upon 50% deposit confirmation .







M1 box frame mirror

vertical LED lights



110V STRIP LED 9.6 W/MT 12V 4200°K

   **IP 44**

infrared sensor switch

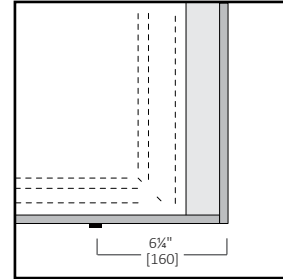

M1 box frame finish



White Matte lacquer · 01M

M2 frameless mirror

LED perimeter light

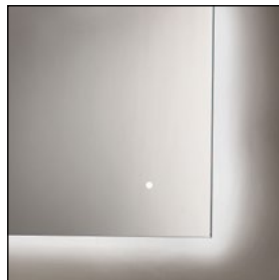

110V STRIP LED 9.6 W/MT 12V 4200°K

   **IP 44**

touch sensor switch

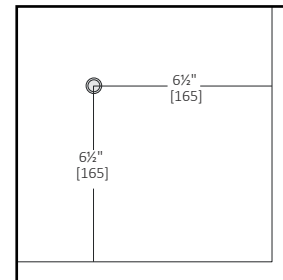

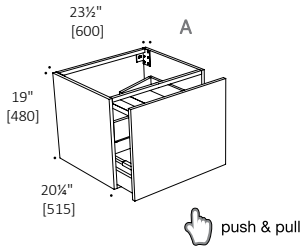

F51V1-0600

- 23½" W × 19" H × 20¼" D / 600mm W x 480mm H x 515mm D
- Wall-mount vanity with deep drawer + slim drawer insert
- Slim inner drawer designed for plumbing clearance
- Hettich push/pull drawer opening system
- Designed to coordinate with series 600 blu-stone™ vanity top basin or countertop.
- Choice of five Hard Surface Technology (HST) finishes; White Matte (01M) or Gloss (01G) lacquer
- Optional drawer organization available.

vanity in lacquer finish

- F51V1-0600-01M *(in stock)*
- F51V1-0600-01G* *(special order)*

or

vanity in HST finish

- F51V1-0600-K31* *(special order)*
- F51V1-0600-K33* *(special order)*

* special order finishes require 16 - 20 weeks lead time upon 50% deposit confirmation *

+

- Ⓐ blu-stone™ vanity top + countertop
View options, refer to page 84

51 furniture

How to order 51 vanities:

Vanity SKU + finish/color code
eg. FULL series 600 vanity in charlestone (K33) HST finish = **F51V1-0600-K33**

Stocked



Special Finish

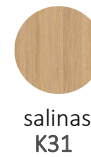

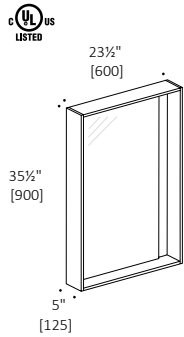

F51M1-0600-01M

- 23½" W × 35½" H × 5" D / 600mm W x 900mm H x 125mm D
- M1 box perimeter frame mirror with two vertical LED lights and discrete infrared switch
- 110V strip LED 4200K
- Frame serves as an integral shelf and is available in White Matte lacquer finish

**Limited Stock*

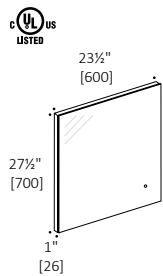

F51M2-0600

- 23½" W × 27½" H × 1" D / 600mm W x 700mm H x 26mm D
- M2 frameless mirror with LED perimeter light and touch sensor switch on mirror face
- 110V strip LED 4.8 W/MT 4200K

**Limited Stock*

How to order 51 mirrors:

Mirror SKU + finish/color code (if applicable)

eg. series 600 M1 box mirror in White Matte (01M) lacquer finish = **F51M1-0600-01M**

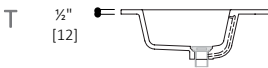
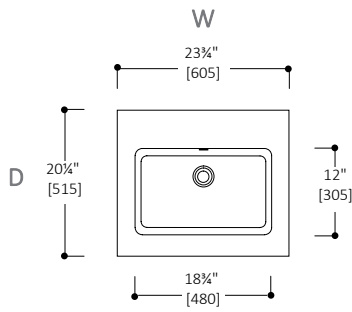

Special Order



Top 23

SA0600.01-01M
SA0600.01-01G*

(matte white)

(in stock)

(gloss white)

(special order)

- 23³/₄" W x 20¹/₄" D x 1/2" T / 605mm W x 515mm D x 12mm T
- blu-stone™ vanity top with integrated basin and integral slot overflow
- Basin: 18³/₄" W x 5" H x 12" D / 480mm W x 128mm H x 305mm D
- Knockouts may be drilled on-site for deck-mount faucet
- Includes matching blu-stone™ waste cover
- Available in a range of blu-stone™ colors + finishes
- Designed to coordinate with series 600 51 collection vanity only
- Recommend QTW-0121 push button waste; designed for use with blu-stone™ waste cover or SC015 universal push button waste

Special Order Finishes

for 1/2" or 1" - 4" apron thickness:



*Special Order finishes require a 20+ week lead time

*Special Order finishes are Made to Order, non-returnable

*Any Sherwin Williams color is available without additional up-charge and based on 1 round of sample

* advise height when ordering

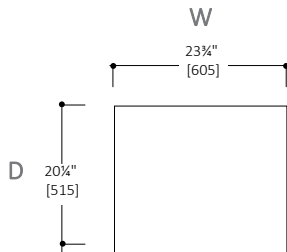

1/2" thickness

SAC0600.01-01M*

- 23³/₄" W x 20¹/₄" D x 1/2" T / 605mm W x 515mm D x 15mm T
- blu-stone™ vanity countertop
- May be drilled on-site for deck-mount faucet installation
- Only available in White Matte finish
- Designed to coordinate with series 600 51 collection vanity only

*Special Order finishes require a 20+ week lead time

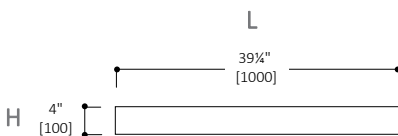

1/2" thickness

SABS1000.01-01M*

- 39¹/₄" W x 4" H x 1/2" D / 1000mm W x 100mm H x 15mm D
- Seamless, blu-stone™ vanity backsplash
- Can be cut to fit on-site
- Only available in White Matte finish
- Coordinate with 51 or 45° collection vanities including: series 600 / 700 / 900

*Special Order finishes require a 20+ week lead time

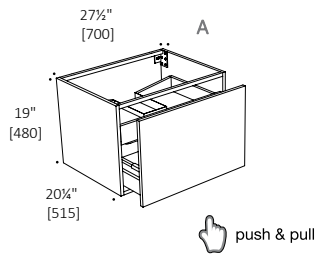

* special order finishes require 16 - 20 weeks lead time upon 50% deposit confirmation *

F51V1-0700

- 27½" W × 19" H × 20¼" D / 700mm W x 480mm H x 515mm D
- Wall-mount vanity with deep drawer + slim drawer insert
- Slim inner drawer designed for plumbing clearance
- Hettich push/pull drawer opening system
- Designed to coordinate with series 700 blu-stone™ vanity top basin or countertop.
- Choice of five Hard Surface Technology (HST) finishes; White Matte (01M) or Gloss (01G) lacquer
- Optional drawer organization available.

vanity in lacquer finish

- F51V1-0700-01M *(in stock)*
- F51V1-0700-01G* *(special order)*

OR

vanity in HST finish

- F51V1-0700-K31* *(special order)*
- F51V1-0700-K33* *(special order)*

+

(A) blu-stone™ vanity top + countertop

View options, refer to page 87

How to order 51 vanities:

Vanity SKU + finish/color code

eg. FULL series 700 vanity in Salinas (K31) HST finish = **F51V1-0700-K31**

Stocked

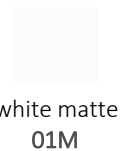

Special Finish

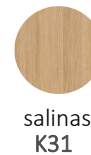

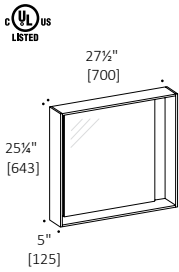

F51M1-0700-01M

- 27½" W × 25¼" H × 5" D / 700mm W x 643mm H x 255mm D
- M1 box perimeter frame mirror with two vertical LED lights and discrete infrared switch
- 110V strip LED 4200K
- Frame serves as an integral shelf and is available in White Matte lacquer finish.

*Limited Stock

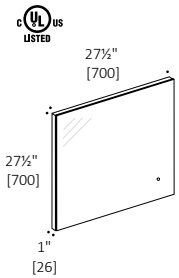

F51M2-0700

- 27½" W × 27½" H × 1" D / 700mm W x 700mm H x 26mm D
- M2 frameless mirror with LED perimeter light and touch sensor switch on mirror face
- 110V strip LED 4.8 W/MT 4200K

*Limited Stock

How to order 51 mirrors:

Mirror SKU + finish/color code (if applicable)

eg. series 700 M1 box mirror in White Matte (01M) lacquer finish = **F51M1-0700-01M**

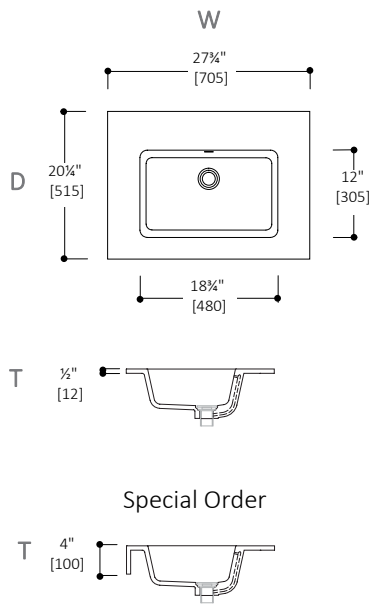

Top 27

SA0700.01-01M (matte white) (in stock)
SA0700.01-01G* (gloss white) (special order)

- 27 3/4" W x 20 1/4" D x 1/2" T / 705mm W x 515mm D x 12mm T
- blu-stone™ vanity top with integrated basin and integral slot overflow
- Basin: 18 3/4" W x 5" H x 12" D / 480mm W x 128mm H x 305mm D
- Knockouts may be drilled on-site for deck-mount faucet
- Includes matching blu-stone™ waste cover
- Available in a range of blu-stone™ colors + finishes
- Designed to coordinate with series 700 45º or 51 collection vanities (refer to pg 102 B)
- Recommend QTW-0121 push button waste; designed for use with blu-stone™ waste cover or SC015 universal push button waste

Special Order Finishes

for 1/2" or 1" - 4" apron thickness:



*Special Order finishes require a 20+ week lead time
 *Special Order finishes are Made to Order, non-returnable
 *Any Sherwin Williams color is available without additional up-charge and based on 1 round of sample

* advise height when ordering

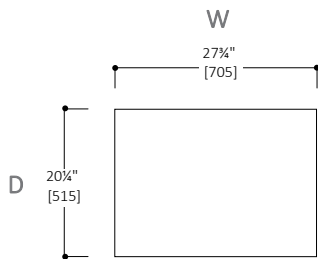

1/2" thickness

SAC0700.01-01M*

- 27 3/4" W x 20 1/4" D x 1/2" T / 705mm W x 515mm D x 12mm T
- blu-stone™ vanity countertop
- May be drilled on-site for deck-mount faucet installation
- Only available in White Matte finish
- Designed to coordinate with series 700 45º or 51 collection vanities

*Special Order finishes require a 20+ week lead time

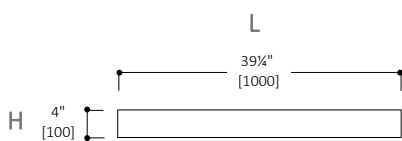

1/2" thickness

SABS1000.01-01M*

- 39 3/4" W x 4" H x 1/2" D / 1000mm W x 100mm H x 12mm D
- Seamless, blu-stone™ vanity backsplash
- Can be cut to fit on-site
- Only available in White Matte finish
- Coordinate with 45º or 51 collection vanities including: series 600 / 700 / 900

*Special Order finishes require a 20+ week lead time



51 collection series 600 vanity F51V1-0600-01M

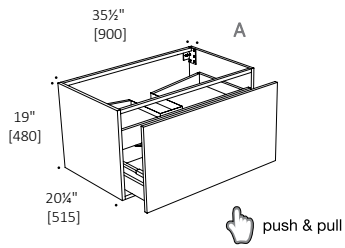

F51V1-0900

- 35½" W × 19" H × 20¼" D / 900mm W x 480mm H x 515mm D
- Wall-mount vanity with deep drawer + slim drawer insert
- Slim inner drawer designed for plumbing clearance
- Hettich push/pull drawer opening system
- Designed to coordinate with series 900 blu-stone™ vanity top basin or countertop.
- Choice of five Hard Surface Technology (HST) finishes; White Matte (01M) or Gloss (01G) lacquer
- Optional drawer organization available.

vanity in lacquer finish

F51V1-0900-01M *(in stock)*
 F51V1-0900-01G* *(special order)*

OR

vanity in HST finish

F51V1-0900-K31* *(special order)*
 F51V1-0900-K33* *(special order)*

+

(A) blu-stone™ vanity top + countertop
 View options, refer to page 91

How to order 51 vanities:

Vanity SKU + finish/color code
 eg. FULL series 900 vanity in Salinas (K31) HST finish = **F51V1-0900-K31**

Stocked



Special Finish



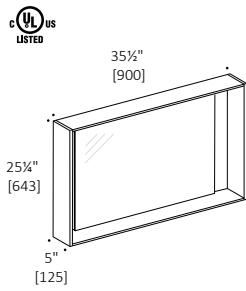

F51M1-0900-01M

- 35 1/2" W × 25 1/4" H × 5" D / 900mm W x 643mm H x 125mm D
- M1 box perimeter frame mirror with two vertical LED lights and discrete infrared switch
- 110V strip LED 4200K
- Frame serves as an integral shelf and is available in White Matte lacquer finish

*Limited Stock

How to order 51 mirrors:

Mirror SKU + finish/color code (if applicable) eg.
series 900 M2 frameless mirror = **F51M2-0900**

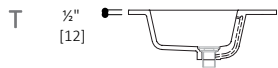
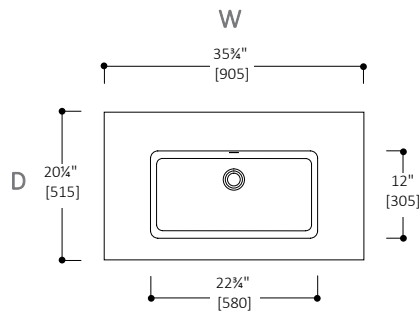

Special Order

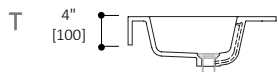

Top 35

SA0900.01-01M

(matte white)

(in stock)

SA0900.01-01G*

(gloss white)

(special order)

- 35 3/4" W x 20 1/4" D x 1/2" T / 905mm W x 515mm D x 12mm T
- blu-stone™ vanity top with integrated basin and integral slot overflow
- Basin: 18 3/4" W x 5" H x 12" D / 480mm W x 128mm H x 305mm D
- Knockouts may be drilled on-site for deck-mount faucet
- Includes matching blu-stone™ waste cover
- Available in a range of blu-stone™ colors + finishes
- Designed to coordinate with series 900 45º or 51 collection vanities
- Recommend QTW-0121 push button waste; designed for use with blu-stone™ waste cover or SC015 universal push button waste

Special Order Finishes

for 1/2" or 1" - 4" apron thickness:



*Special Order finishes require a 20+ week lead time

*Special Order finishes are Made to Order, non-returnable

*Any Sherwin Williams color is available without additional up-charge and based on 1 round of sample

* advise height when ordering

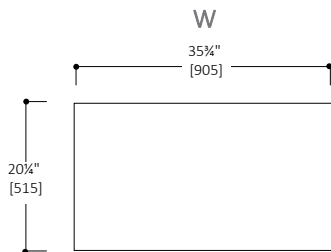

1/2" thickness

SAC0900.01-01M*

- 35 3/4" W x 20 1/4" D x 1/2" T / 905mm W x 515mm D x 12mm T
- blu-stone™ vanity countertop
- May be drilled on-site for deck-mount faucet installation
- Only available in White Matte finish
- Designed to coordinate with series 900 45º or 51 collection vanities

*Special Order finishes require a 20+ week lead time

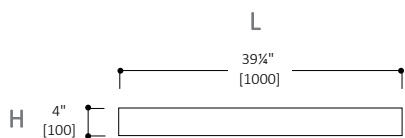

1/2" thickness

SABS1000.01-01M*

- 39 1/4" W x 4" H x 1/2" D / 1000mm W x 100mm H x 12mm D
- Seamless, blu-stone™ vanity backsplash
- Can be cut to fit on-site
- Only available in White Matte finish
- Coordinate with 45º or 51 collection vanities including: series 600 / 700 / 900

*Special Order finishes require a 20+ week lead time

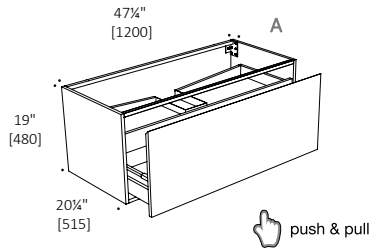

F51V1-1200

- 47 1/4" W x 19" H x 20 1/4" D / 1200mm W x 480mm H x 515mm D
- Wall-mount vanity with deep drawer + slim drawer insert
- Slim inner drawer designed for plumbing clearance
- Hettich push/pull drawer opening system
- Designed to coordinate with series 1200 blu-stone™ vanity top basin or countertop.
- Choice of five Hard Surface Technology (HST) finishes; White Matte (01M) or Gloss (01G) lacquer
- Optional drawer organization available.

vanity in lacquer finish

- F51V1-1200-01M *(in stock)*
- F51V1-1200-01G* *(special order)*

or

vanity in HST finish

- F51V1-1200-K31* *(special order)*
- F51V1-1200-K33* *(special order)*

+

Ⓐ **blu-stone™ vanity top + countertop View**
options, refer to page 94

How to order 51 vanities:

Vanity SKU + finish/color code
eg. FULL series 1200 vanity in Charlestone (K33) HST finish = **F51V1-1200-K33**

Stocked



Special Finish

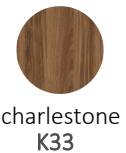
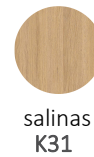

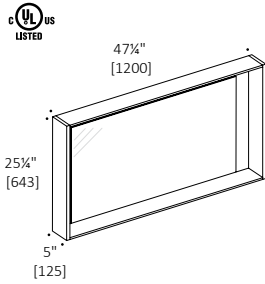

F51M1-1200-01M

- 47¼" W × 25¼" H × 5" D / 1200mm W x 643mm H x 125mm D
- M1 box perimeter frame mirror with two vertical LED lights and discrete infrared switch
- 110V strip LED 4200K
- Frame serves as an integral shelf and is available in White Matte lacquer finish

*Limited Stock

How to order 51 mirrors:

Mirror SKU + finish/color code (if applicable)

eg. series 1200 M1 box mirror in White Matte (01M) lacquer finish = **F51M1-1200-01M**

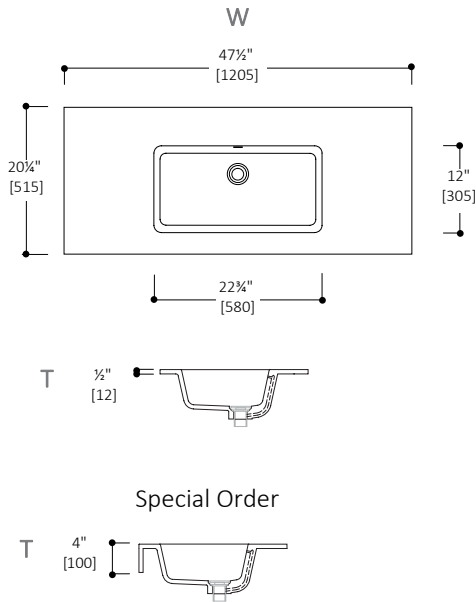

Top 47

SA1200.01-01M
SA1200.01-01G*

(matte white) (in stock)
(gloss white) (special order)

- 47 1/2" W x 20 1/4" D x 1/2" T / 1205mm W x 515mm D x 12mm T
- blu-stone™ vanity top with integrated basin and integral slot overflow
- Basin: 22 3/4" W x 5" H x 12" D / 580mm W x 128mm H x 305mm D
- Knockouts may be drilled on-site for deck-mount faucet
- Includes matching blu-stone™ waste cover
- Available in a range of blu-stone™ colors + finishes
- Designed to coordinate with series 1200 45º or 51 collection vanities
- Recommend QTW-0121 push button waste; designed for use with blu-stone™ waste cover or SC015 universal push button waste

Special Order Finishes

for 1/2" or 1" - 4" apron thickness:



- *Special Order finishes require a 20+ week lead time
- *Special Order finishes are Made to Order, non-returnable
- *Any Sherwin Williams color is available without additional up-charge and based on 1 round of sample

* advise height when ordering

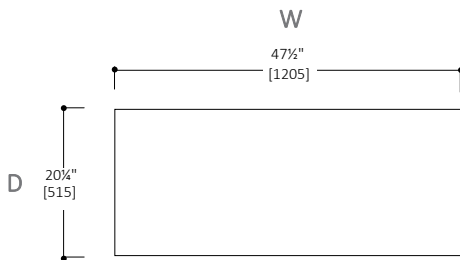

1/2" thickness

SAC1200.01-01M*

- 47 1/2" W x 20 1/4" D x 1/2" T / 1205mm W x 515mm D x 12mm T
- blu-stone™ vanity countertop
- May be drilled on-site for deck-mount faucet installation
- Only available in White Matte finish
- Designed to coordinate with series 1200 45º or 51 collection vanities

*Special Order finishes require a 20+ week lead time

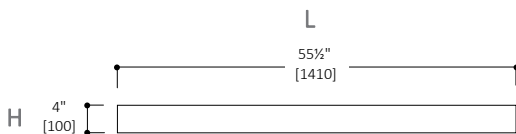

1/2" thickness

SABS1400.01-01M*

- 55 1/2" W x 4" H x 1/2" D / 1410mm W x 100mm H x 12mm D
- Seamless, blu-stone™ vanity backsplash
- Can be cut to fit on-site
- Only available in White Matte finish
- Coordinate with 45º or 51 collection vanities including: series 1200 (to be cut on-site) / 1400

*Special Order finishes require a 20+ week lead time

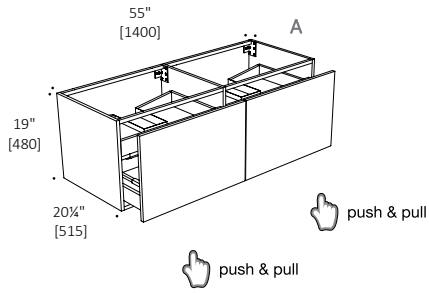

F51V1-1400

- 55" W x 19" H x 20¼" D / 1400mm W x 480mm H x 515mm D
- Wall-mount double vanity with two deep drawers + slim drawer inserts
- Slim inner drawers designed for plumbing clearance
- Hettich push/pull drawer opening system
- Designed to coordinate with series 1400 blu-stone™ vanity top basin or countertop.
- Choice of five Hard Surface Technology (HST) finishes; White Matte (01M) or Gloss (01G) lacquer
- Optional drawer organization available.

vanity in lacquer finish

F51V1-1400-01M *(in stock)*
 F51V1-1400-01G* *(special order)*

OR

vanity in HST finish

F51V1-1400-K31* *(special order)*
 F51V1-1400-K33* *(special order)*

+

(A) blu-stone™ vanity top + countertop

View options, refer to pages 97-98

How to order 51 vanities:

Vanity SKU + finish/color code

eg. FULL series 1400 vanity in Charlestone (K33) HST finish = **F51V1-1400-K33**

Stocked

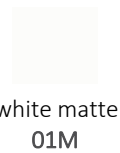

Special Finish

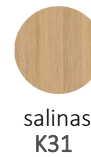

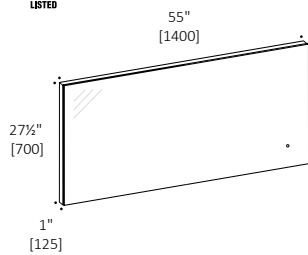

F51M2-1400

- 55" W × 27½" H × 1" D / 1400mm W x 700mm H x 26mm D
- M2 frameless mirror with LED perimeter light and touch sensor switch on mirror face
- 110V strip LED 4.8 W/MT 4200K

* Limited Stock

How to order 51 mirrors:

Mirror SKU + finish/color code (if applicable) eg.
series 1400 M2 frameless mirror **F51M2-1400**

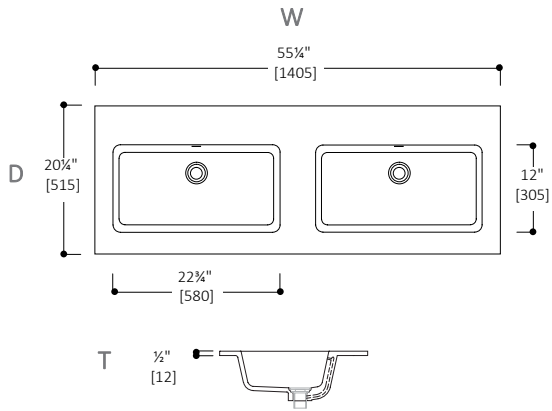

Special Order



Top 55

SA1400.01-01M

(matte white)

(in stock)

SA1400.01-01G*

(gloss white)

(special order)

- 55 1/4" W x 20 3/4" D x 1/2" T / 1405mm W x 515mm D x 12mm T
- blu-stone™ double vanity top with integrated basins and integral slot overflows
- Basins: 22 3/4" W x 5" H x 12" D / 580mm W x 128mm H x 305mm D
- Knockouts may be drilled on-site for deck-mount faucet
- Includes matching blu-stone™ waste covers
- Only available in White Matte or White Gloss finish
- Designed to coordinate with series 1400 45º or 51 collection vanities
- Recommend QTW-0121 push button waste; designed for use with blu-stone™ waste cover or SC015 universal push button waste (refer to pg 31 A)

Special Order Finishes

for 1/2" or 1" - 4" apron thickness:



*Special Order finishes require a 20+ week lead time

*Special Order finishes are Made to Order, non-returnable

*Any Sherwin Williams color is available without additional up-charge and based on 1 round of sample

* advise height when ordering

Top 55L

SA1401.01-01M

(matte white)

(in stock)

SA1401.01-01G*

(gloss white)

(special order)

- 55 1/4" W x 20 3/4" D x 1/2" T / 1405mm W x 515mm D x 12mm T
- blu-stone™ vanity top with integrated left offset basin and integral slot overflow
- Basin: 22 3/4" W x 5" H x 12" D / 580mm W x 128mm H x 305mm D
- Knockouts may be drilled on-site for deck-mount faucet
- Includes matching blu-stone™ waste cover
- Only available in White Matte or White Gloss finish
- Designed to coordinate with series 1400 45º or 51 collection vanities
- Recommend QTW-0121 push button waste; designed for use with blu-stone™ waste cover or SC015 universal push button waste

Special Order Finishes

for 1/2" or 1" - 4" apron thickness:



*Special Order finishes require a 20+ week lead time

*Special Order finishes are Made to Order, non-returnable

*Any Sherwin Williams color is available without additional up-charge and based on 1 round of sample

* advise height when ordering

Top 55R

SA1402.01-01M

(matte white)

(in stock)

SA1402.01-01G*

(gloss white)

(special order)

- 55¼" W x 20¼" D x ½" T / 1405mm W x 515mm D x 12mm T
- blu-stone™ vanity top with integrated right offset basin and integral slot overflow
- Basin: 22¾" W x 5" H x 12" D / 580mm W x 128mm H x 305mm D
- Knockouts may be drilled on-site for deck-mount faucet
- Includes matching blu-stone™ waste cover
- Only available in White Matte or White Gloss finish
- Designed to coordinate with series 1400 45° or 51 collection vanities
- Recommend QTW-0121 push button waste; designed for use with blu-stone™ waste cover or SC015 universal push button waste

Special Order Finishes

for ½" or 1" - 4" apron thickness:



*Special Order finishes require a 20+ week lead time

*Special Order finishes are Made to Order, non-returnable

*Any Sherwin Williams color is available without additional up-charge and based on 1 round of sample

* advise height when ordering

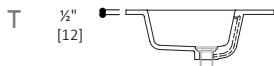
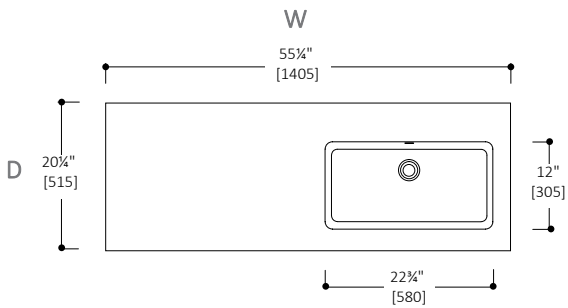

Special Order



½" thickness

SAC1400.01-01M*

- 55¼" W x 20¼" D x ½" T / 1405mm W x 515mm D x 12mm T
- blu-stone™ vanity countertop
- May be drilled on-site for deck-mount faucet installation
- Only available in White Matte finish
- Designed to coordinate with series 1400 45° or 51 collection vanities

*Special Order finishes require a 20+ week lead time

½" thickness

SABS1400.01-01M*

- 55½" W x 4" H x ½" D / 1410mm W x 100mm H x 12mm D
- Seamless, blu-stone™ vanity backsplash
- Can be cut to fit on-site
- Only available in White Matte finish
- Coordinate with 45° or 51 collection vanities including: series 1200 (to be cut on-site) / 1400

*Special Order finishes require a 20+ week lead time

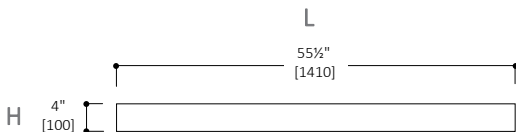
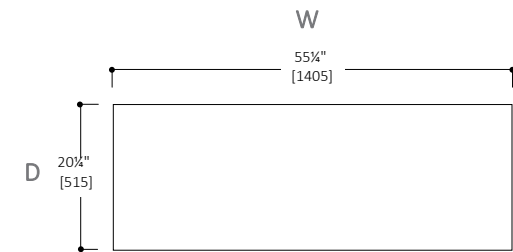

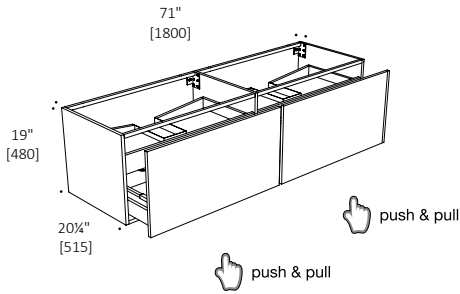

F51V1-1800

- 71" W x 19" H x 20¼" D / 1800mm W x 480mm H x 515mm D
- Wall-mount double vanity with two deep drawers + slim drawer inserts
- Slim inner drawers designed for plumbing clearance
- Hettich push/pull drawer opening system
- Designed to coordinate with series 1800 blu-stone™ vanity top basin or countertop.
- Choice of five Hard Surface Technology (HST) finishes; White Matte (01M) or Gloss (01G) lacquer
- Optional drawer organization available.

vanity in lacquer finish

F51V1-1800-01M *(in stock)*
 F51V1-1800-01G* *(special order)*

or

vanity in HST finish

F51V1-1800-K31* *(special order)*
 F51V1-1800-K33* *(special order)*

+
 (A) **blu-stone™ vanity top + countertop**
 View options, refer to pages 100-101

How to order 51 vanities:

Vanity SKU + finish/color code
 eg. FULL series 1800 vanity in White Matte (01M) lacquer finish = **F51V1-1800-01M**

Stocked

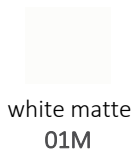

Special Finish

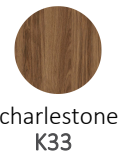
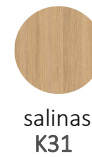

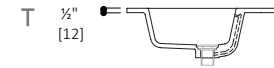
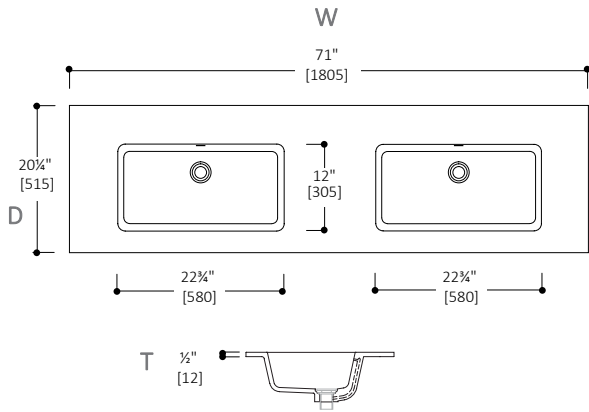

Special Order

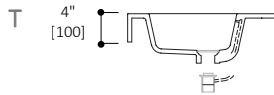

Top 71

SA1800.01-01M
SA1800.01-01G*

(matte white)

(in stock)

(gloss white)

(special order)

- 71" W x 20 3/4" D x 1/2" T / 1805mm W x 515mm D x 12mm T
- blu-stone™ double vanity top with integrated basins and integral slot overflows
- Basins: 22 3/4" W x 5" H x 12" D / 580mm W x 128mm H x 305mm D
- Knockouts may be drilled on-site for deck-mount faucet
- Includes matching blu-stone™ waste covers
- Only available in White Matte or White Gloss finish
- Designed to coordinate with series 1800 45° or 51 collection vanities.
- Recommend QTW-0121 push button waste; designed for use with blu-stone™ waste cover or SC015 universal push button waste

Special Order Finishes

for 1/2" or 1" - 4" apron thickness:



*Special Order finishes require a 20+ week lead time

*Special Order finishes are Made to Order, non-returnable

*Any Sherwin Williams color is available without additional up-charge and based on 1 round of sample

* advise height when ordering

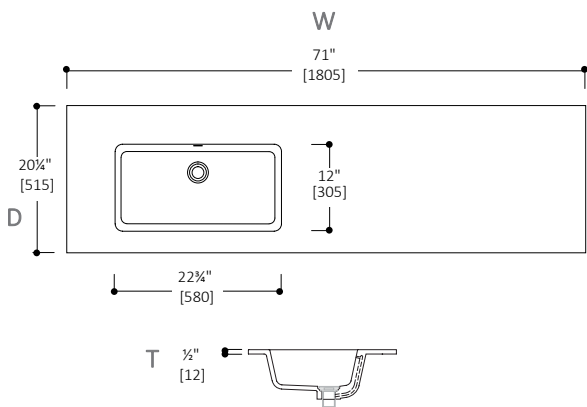

Special Order



Top 71L

SA1801.01-01M*
SA1801.01-01G*

(matte white)

(in stock)

(gloss white)

(special order)

- 71" W x 20 3/4" D x 1/2" T / 1805mm W x 515mm D x 12mm T
- blu-stone™ vanity top with integrated left offset basin and integral slot overflow
- Basin: 22 3/4" W x 5" H x 12" D / 580mm W x 128mm H x 305mm D
- Knockouts may be drilled on-site for deck-mount faucet
- Includes matching blu-stone™ waste cover
- Only available in White Matte or White Gloss finish
- Designed to coordinate with series 1800 45° or 51 collection vanities
- Recommend QTW-0121 push button waste; designed for use with blu-stone™ waste cover or SC015 universal push button waste

Special Order Finishes

for 1/2" or 1" - 4" apron thickness:



*Special Order finishes require a 20+ week lead time

*Special Order finishes are Made to Order, non-returnable

*Any Sherwin Williams color is available without additional up-charge and based on 1 round of sample

* advise height when ordering

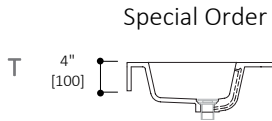
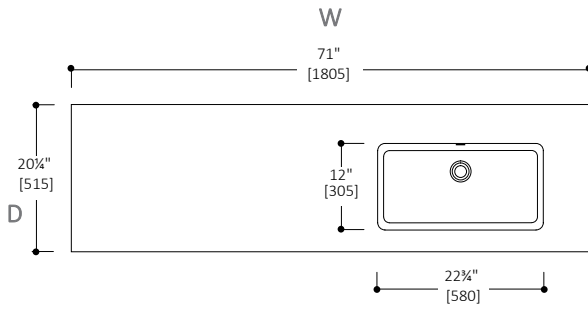

Top 71R

SA1802.01-01M*

(matte white)

(in stock)

SA1802.01-01G*

(gloss white)

(special order)

- 71" W x 20 1/4" D x 1/2" T / 1805mm W x 515mm D x 12mm T
- blu-stone™ vanity top with integrated right offset basin and integral slot overflow
- Basins: 22 3/4" W x 5" H x 12" D / 580mm W x 128mm H x 305mm D
- Knockouts may be drilled on-site for deck-mount faucet
- Includes matching blu-stone™ waste covers
- Only available in White Matte or White Gloss finish
- Designed to coordinate with series 1800 45° or 51 collection vanities
- Recommend QTW-0121 push button waste; designed for use with blu-stone™ waste cover or SC015 universal push button waste

Special Order Finishes

for 1/2" or 1" - 4" apron thickness:



*Special Order finishes require a 20+ week lead time

*Special Order finishes are Made to Order, non-returnable

*Any Sherwin Williams color is available without additional up-charge and based on 1 round of sample

* advise height when ordering

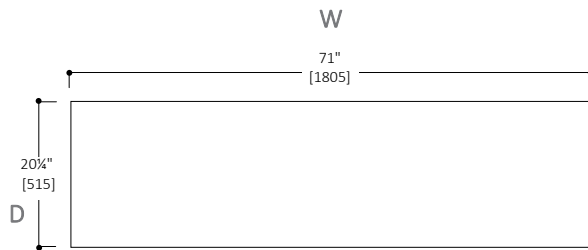

1/2" thickness

SAC1800.01-01M*

- 71" W x 20 1/4" D x 1/2" T / 1805mm W x 515mm D x 12mm T
- blu-stone™ vanity countertop
- May be drilled on-site for deck-mount faucet installation
- Only available in White Matte finish
- Designed to coordinate with series 1800 45° or 51 collection vanities

*Special Order finishes require a 20+ week lead time

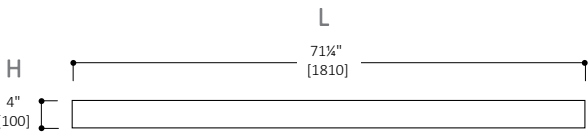

1/2" thickness

SABS1800.01-01M*

- 71 1/4" W x 4" H x 1/2" D / 1810mm W x 100mm H x 12mm D
- Seamless, blu-stone™ vanity backsplash
- Can be cut to fit on-site
- Only available in White Matte finish
- Coordinate with 45° or 51 collection vanities including: series 1800

*Special Order finishes require a 20+ week lead time

SC015

- Universal push button waste,
- Suitable for both overflow and no overflow applications
- Shrouded threads + tailpiece included with waste
- Stainless steel AISI316L

finish

- AS
- ON*
- OC*

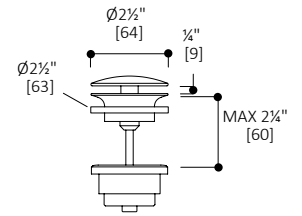

*Finishes: ON, OC are Special Order items and require a 6-8 week lead time upon order confirmation

QTW-0120

- Push button waste without overflow
- Shrouded threads + tailpiece included with waste
- Stainless steel AISI316L
- Designed for use with blu·stone™ waste cover

finish

- AS

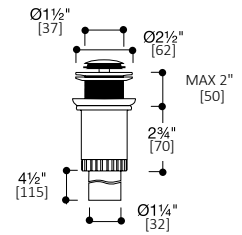

QTW-0121

- Push button waste with overflow
- Shrouded threads + tailpiece included with waste
- Stainless steel AISI316L
- Designed for use with blu·stone™ waste cover

finish

- AS

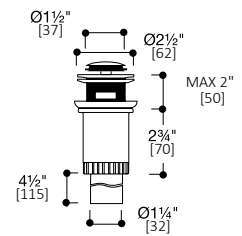



F01AC-01

- Kit includes 2 storage compartments, suitable for all 45°, 45° FENIX™ and 51 vanities
- Individual Storage Compartment:
10½" L x 5½" W x 1¼" H / 269mm L x 139mm W x 42mm H
- Ideal for organizing make-up brushes and other beauty accessories



F01AC-02

- Kit includes 2 cosmetic holders, suitable for all 45°, 45° FENIX™ and 51 vanities
- Individual Cosmetic Holder:
5½" L x 2¾" W x 1½" H / 139mm L x 73mm W x 41mm H
- Ideal for organizing nail polishes, lipsticks, beauty pencils and other small items



F01AC-03

- Kit includes 2 storage bin sets, suitable for all 45°, 45° FENIX™ and 51 vanities
- Individual Storage Bin:
13¾" L x 5¾" W x 2¾" H / 334mm L x 146mm W x 41mm H
- Ideal for storing jewellery, cotton balls and other essentials



F01AC-04

- Kit includes 1 tissue box, suitable for all 45°, 45° FENIX™ and 51 vanities
- Tissue Box:
11¼" L x 6¼" W x 3½" H / 286mm L x 156mm W x 90mm H



F45AC-01

- Drawer filler designed to slot into the slim inner drawer of series 1400 + 1800 45° and 45° FENIX™ collection vanities
- Provides additional storage space when plumbing clearance is not required
- Drawer filler:
7¼" W x 2¼" H x 10" D / 182mm W x 59mm H x 251mm D

warranty

limited blu-stone™ residential warranty

Blu Bathworks® (“Blu”) blu-stone™ products are warranted to the original purchaser to be free from defects in all material and workmanship during normal residential use for a period of five (5) years from the date of purchase. Blu will, at its election, repair, provide a replacement part or product, or make appropriate adjustment, subject to the terms and conditions set forth in this warranty. Blu Bathworks does not recommend exceeding US/Canada maximum hot water temperature regulations of 150°F / 65°C, respectively. Exceeding stated temperatures could result in damage to blu-stone™ basins and bathtubs. Bathtub/basin drains and parts are warranted for a period of 1 year.

limited furniture residential warranty

Blu Bathworks® (“Blu”) furniture products are warranted to the original purchaser to be free from defects in all material and workmanship during normal residential use for a period of one (5) years from the date of purchase. Blu will, at its election, repair, provide a replacement part or product, or make appropriate adjustment, subject to the terms and conditions set forth in this warranty. The painted finish is warranted for a period of 2 years; furniture accessories and parts are warranted for a period of 1 year.

limited tapware residential warranty

Blu Bathworks® (“Blu”) tapware products are warranted to the original purchaser to be free from defects in all mechanical parts and polished chrome finishes during normal residential use for as long as the original purchaser owns his or her home. Blu will, at its election, repair, provide a replacement part or product, or make appropriate adjustment, subject to the terms and conditions set forth in this warranty. The painted finish is warranted for a period of 2 years. Normal wear and tear on parts is warranted for a period of 1 year.

limited commercial warranty

Blu Bathworks® (“Blu”) products are warranted to the original purchaser to be free from defects in all material and workmanship during normal usage for a period of one (1) year from the date of purchase. Blu will, at its election, repair, provide a replacement part or product, or make appropriate adjustment, subject to the terms and conditions set forth in this warranty.

terms + conditions

This warranty applies only to Blu Bathworks® ("Blu") products distributed in North America.

This warranty is non-transferable and is for the exclusive benefit of the original purchaser of a Blu product. This warranty may be exercised by the original purchaser of a unit in a new residential development. Blu recommends using a professional plumber for all installation and repair.

This warranty does not apply to products that have been installed in any manner other than as set out in Blu's installation guides, or to products that have been altered in any way.

For further clarity, the above stated warranty does not cover or apply to damage attributable to:

- a. neglect, misuse, abuse, accident or negligence;
- b. normal wear and tear, such as gloss reduction, scratching or fading over time due to use, cleaning practices or water or atmospheric condition, including but not limited to, the use of bleach, alkali, acid cleaners, dry (powder) cleaners or any other abrasive cleaners or the use of metal or nylon scrubbers.
- c. dirt or lime scale, or improper care, cleaning, or maintenance of the Product, or the use of inappropriate cleaners (such as those containing abrasives, ammonia, acids, waxes, bleaches, solvents, alcohol, or any product not recommended for chrome);
- d. damage caused by transportation, or improper storage;
- e. a natural calamity such as fire, earthquake, flood, thunder, electrical storm, etc.;
- f. sediments or foreign matter contained in a water system;
- g. damage or loss resulting from improper installation or from installation of the Product in a harsh and/or hazardous environment, or improper removal, repair or modification of the Product;
- h. electrical surges or lightning strikes or other acts which are not the fault of Blu Bathworks or which the Product is not specified to tolerate;
- i. the use of any Product in a manner inconsistent with the Product instructions / owners manual; and
- j. any failure, or damage to, this Product caused by either chloramines in the treatment of public water supply or cleaners containing chlorine (calcium hypochlorite).

NOTE: The use of high concentrate chlorine or chlorine related products can seriously damage the fittings. This damage can cause leakage and serious property damage.

- k. tub and basin drain caps, aerators, cartridges/check valves included in some Tapware and Blu.stone products, due to being an expendable item
- l. The supply lines must be flushed out to prevent clogging of the filter screens. Failure to flush the lines will permanently damage the cartridge and void the warranty,

This is the only warranty of Blu, which makes no other warranty of any kind. Blu disclaims any liability for special, incidental or consequential damages.

In no event shall the liability of Blu under this warranty exceed the purchase price of the product.

PROCEDURE FOR WARRANTY SERVICE

Refer to blubathworks.com for policy and procedures relating to requests for service under the terms of this warranty.

Original proof of purchase is required. Blu is not responsible for removal or installation costs, or the costs of shipping and handling associated with any service. Repaired or replaced products or parts are warranted only for the period remaining under the initial warranty.

For warranty eligibility, a completed & signed Return Goods Authorization (RGA) form must be emailed to Blu Bathworks® at support@blubathworks.com, which includes all relevant information regarding your claim, including:

- Product /SKU number
- Proof-of-purchase (copy of your original sales receipt, purchase order, or invoice), the date the product was purchased and installation date
- Complete description of the problem with supporting documentation as applicable (such as photographs)

Note: Failure to provide any required information will void the warranty.

Any damages resulting from transportation or missing parts must be reported to Blu within 5 days of receipt by the consignee. Please allow 7 to 14 business days for warranty processing.

Special Order items are not subject to cancellation or return.

inventory

Blu Bathworks' categorizes standard in-stock inventory items versus special order items and provides an estimated guideline for fulfillment of non-stocked furniture + blu·stone™ items, as outlined below.

Lead times indicated are approximative from order confirmation date and do not include shipping within North America.

*Special Order items require a 50% non-refundable deposit at time of order acceptance.

Note: The maximum Dealer discount on 45° FENIX NTM™ furniture is 50% (.5 multiplier)

45° furniture collection Stock: inventory *Special Order: 20+ week

"FULL" + "UP vanity frames		"FULL" + "UP vanity + Cabinet drawer fronts		"M1" mirror		Cabinet frames	
01M	stock	02	stock	01M	stock	01M	stock
02	special order	03 + 04 + 05 + 08 + 09	special order	02	stock	02	special order
		lacquer	special order				

45° FENIX NTM™ furniture collection

"FULL" + "UP FENIX™" vanity frames		"FULL" + "UP FENIX™ vanity drawer fronts		"FULL" + "UP vanity drawer fronts		"M1" mirror	
01M	special order	01M	special order	02+03+04+05+08+09	special order	01M	stock
04M	special order	04M	special order	lacquer	special order	04M	special order

Cabinet frames + door fronts
special order

51 furniture collection Stock: inventory

"FULL" vanities		"M1 + M2" mirrors	
01M	stock	box	stock
01G	special order	frameless	stock
K31	special order		
K33	special order		

blu·stone™ items Stock: inventory *Special Order: 20+ week

tapware items Stock: inventory *Special Order: 6-8 week

inventory

contact

We pride ourselves in customer service – we’re here to help you and your clients experience the best in design, functionality & service. For your convenience, please use the contact support information listed below.

Phone

Toll free: +1.866.907.0122

Local: +1.604.299.0122

Email

Orders: orders@blubathworks.com

Inquiries: info@blubathworks.com

Support: support@blubathworks.com

Marketing: marketing@blubathworks.com

Online

Website: blubathworks.com

Social Media: [@blubathworks](https://www.instagram.com/blubathworks)

